



TEKİN ŞEMSIYE®

Güvenle Açılan Şemsiye

— Since 1986 —

38+
yıl

ŞEMSIYE VE GÖLGE SİSTEMLERİNDE 38 YILLIK TECRÜBE

Mirasımız

Bazı şeyler vardır, kıymeti ancak yokluğunda anlaşılır, şemsiye gibi. Yağmurda ıslanmadan saklanacak bir kanat, güneşte kavrulmadan sığınacak bir gölge aklımıza gelmez. Derin bir muhabbetin daha başında, altında oturduğumuz şemsiyeyi unutup geçeriz. Güzel bir yemeğin tadına, püfür püfür bir gölgelikte daha fazla vardığımızı bile farketmeyiz.

Konforun Değeri

Bazı şeyler vardır, hayatın konforunu artırır. Farkına varıldıktan sonra ise vazgeçilmez olur. Biz de hayata konfor katmak için 1986 yılında Tekin Şemsiye ile yağmura siper olduk.

Büyümemiz

Yenilikçi bakışımızı koruyarak sürekli gelişmeye ve büyümeye devam ediyoruz.

Başarılarımız:

- Yüksek ürün kalitesi
- Kısa termin süresi
- Satış önce ve sonrası profesyonel destek
- 44 ülkeye ihracat

Liderlik Konumumuz

Bugün faaliyetini sürdürdüğümüz alanların zirvesine ulaşmış bulunmaktayız. Aşağıdaki alanlarda kendimizle yarışarak ilerlemeye devam ediyoruz:

- Yeni teknolojileri keşfetme ve uygulama
- İşçilik kalitesini artırma
- Sektör standartlarını belirleme
- Üstün kalite standartlarını koruma

Temel Yetkinliklerimiz

- Gelişmiş üretim kabiliyetleri
- Yenilikçi tasarım çözümleri
- Kalite kontrol mükemmeliyeti
- Profesyonel proje yönetimi
- Kapsamlı müşteri desteği
- Global dağıtım ağı

38 YEARS OF EXPERTISE IN UMBRELLA AND SHADE SYSTEMS

Our Heritage

Some things are only truly valued in their absence - like an umbrella. A protective wing from the rain, a refuge from the scorching sun - these are comforts we often take for granted. In the midst of deep conversation, we forget about the shade above us. Even while enjoying a fine meal, we rarely notice how much more pleasant it is in the cool shade.

The Value of Comfort

Certain elements enhance life's comfort. Once discovered, they become indispensable. This is the philosophy that drove us to establish Tekin Şemsiye in 1986, becoming a shield against the elements.

Our Growth

We continue to grow and evolve while maintaining our innovative perspective. Our achievements include:

- High product quality
- Short delivery times
- Pre and post-sales professional support
- Exports to 44 countries worldwide

Leadership Position

Today, we have reached the pinnacle in our field of operations. We continue to advance with a vision that can only be measured against our own standards by:

- Discovering and implementing new technologies
- Enhancing craftsmanship
- Setting industry benchmarks
- Maintaining unparalleled quality standards

Core Competencies

- Advanced manufacturing capabilities
- Innovative design solutions
- Quality control excellence
- Professional project management
- Comprehensive customer support
- Global distribution network



NUSRET TEKİN (KURUCU)
EMİNÖNÜ / İSTANBUL 1986



TEKİN ŞEMSIYE
Güvenle Açılan Şemsiye
— Since 1986 —

ALUBRELLA

ALUBRELLA YUVARLAK

ALUBRELLA ROUND



Bahçenizde,havuz kenarında kullanabileceğiniz 6 kollu,alüminyumdan üretilmiş yuvarlak şekilde şemsiyedir.

Şemsiyenin gövdesi beyaz elektrostatik toz boya (RAL 9016) ile kaplıdır.

Şemsiyede kullanılan tüm profiller 13x19 mm. olup et kalınlığı 1.2 mm.'dir.

Şemsiyede kullanılan plastik parçalar entegre tesisimizde üretilmekte olup kırılmaya karşı 2 yıl garantili,ABS Pa6 PRIME hammaddeden üretilmiştir.

Şemsiyenin orta borusu2 parçadan oluşmaktadır.

Şemsiyede kullanılan alt boru Ø39x41 mm. üst boru ise Ø35.8x38.2 mm.'dir.

Şemsiye alt ve üst boruların üzerindeki sıkma sistemi ile sabitlenerek istenilen yükseklik ayarlanabilir.

Şemsiyenin açma-kapama sistemi,kolları birbirine bağlayan orta plastiğin yukarı doğru sürülerek açılması sağlanır.Orta plastiğin aşağı doğru çekilmesiyle kapanır.

Polyester,plastiks,jüt kumaş seçeneğiyle etekli ve eteksiz olarak tercih edilebilir.

Bu ürünlerde orta boruya geçirilen sehpa ve küllük seçeneğiyle daha kullanışlı hale getirilebilir.

Uygun altlık seçenekleri alt bölümde gösterilmiştir.

It is an 6-arm, round umbrella made of aluminum that you can use in your garden, by the pool.

The umbrella body is covered with white electrostatic powder paint (RAL 9016).

All profiles used in the umbrella are 13x19 mm. and its wall thickness is 1.2 mm.

The plastic parts used in the umbrella are produced in our integrated facility and are guaranteed for 2 years against breakage, ABS Pa6 PRIME made from raw material.

The middle pipe of the umbrella consists of 2 parts.

The lower pipe used in the umbrella is Ø39x41 mm. the upper pipe is Ø35.8x38.2 mm.

The desired height can be adjusted by fixing the umbrella with the fixing system on the upper and lower pipes.

The opening-closing system of the umbrella allows the middle plastic connecting the arms to be opened by sliding upwards. It closes by pulling it down.

It can be preferred with or without skirt, with polyester, plastic, jute fabric options.

These products can be made more useful with the option of a coffee table and ashtray attached to the middle pipe.

Suitable pad options are shown in the lower section.

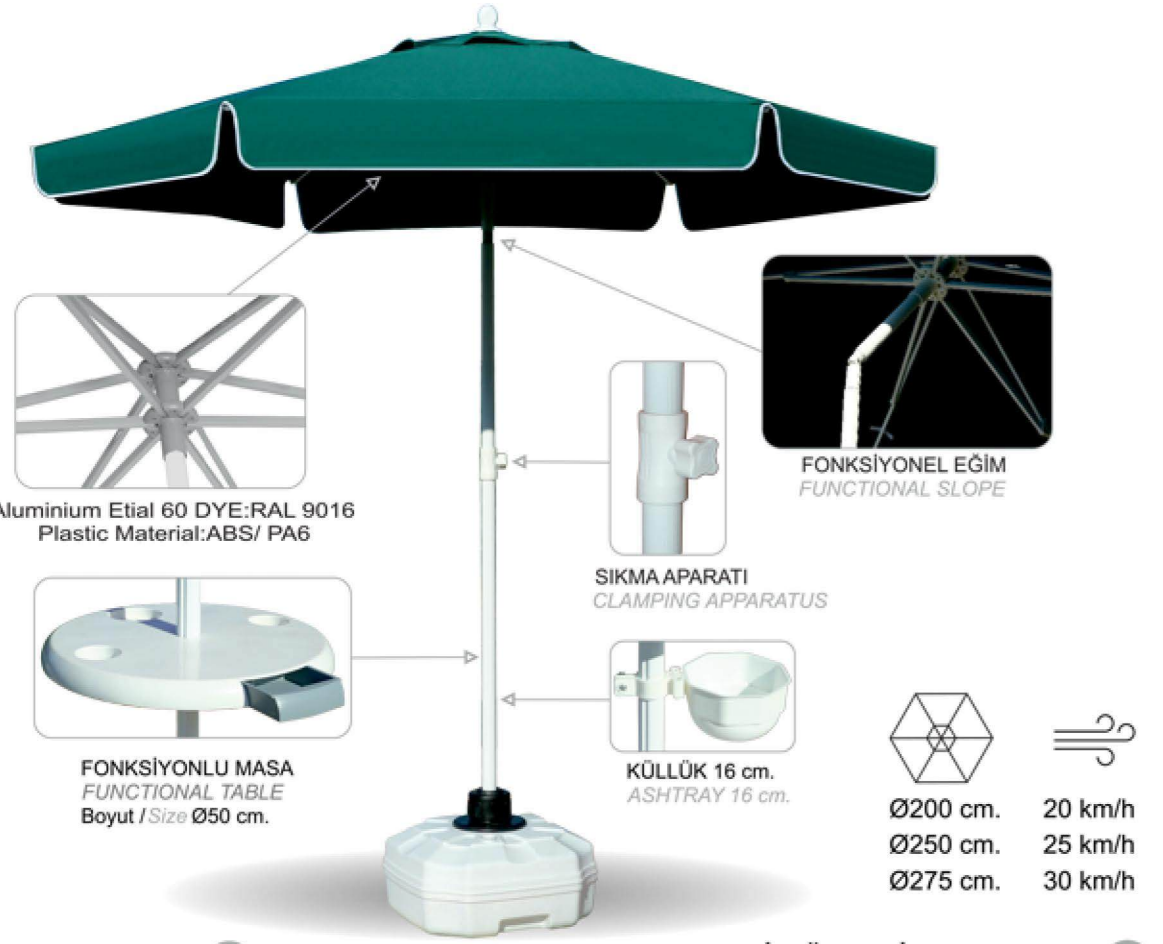

ÖLÇÜLER / SIZES

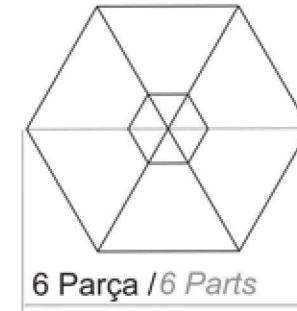

BLR 200/6 Ø200 cm.

BLR 250/6 Ø250 cm.

BLR 275/6 Ø275 cm.

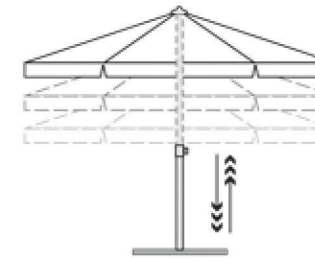

TEKNİK ÖZELLİKLER

TECHNICAL SPECIFICATIONS

KOD CODE	KAPLI ALAN AREA COVERED	AĞIRLIK WEIGHT	AMBALAJ PACKAGING	AMBALAJ PACKAGING
	m ²	kg.	1 ad./pcs.	4 ad./pcs.
BLR 200/6	3	5	15x15x160cm.	27x27x160 cm.
BLR 250/6	5	7	15x15x160cm.	27x27x160 cm.
BLR 275/6	6	8	15x15x175cm.	27x27x175 cm.

PROFİLLER / PROFILES

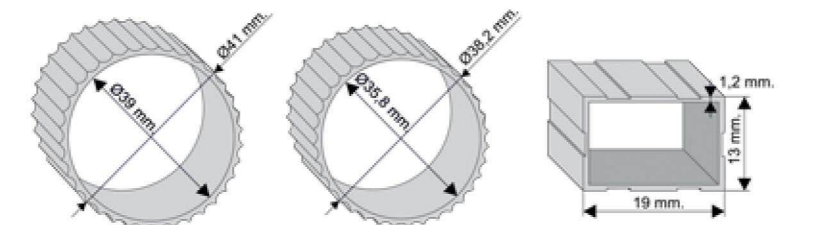

ALTIKLAR / BASES



TKN-301 50x50 cm./ 80 kg.

TKN-W-1040

TKN-LUX-3010 50 kg
BETONLU/CONCRETE

Altıklar fiyatlara dahil değildir.
Bases are not included in the price.

ALUBRELLA KARE

ALUBRELLA SQUARE



Bahçenizde,havuz kenarında kullanabileceğiniz 4 kollu,alüminyumdan üretilmiş kare şeklinde şemsiyedir.

Şemsiyenin gövdesi beyaz elektrostatik toz boya (RAL 9016) ile kaplıdır.

Şemsiyede kullanılan tüm profiller 13x19 mm. olup et kalınlığı 1.2 mm.'dir.

Şemsiyede kullanılan plastik parçalar entegre tesisimizde üretilmekte olup kırılmaya karşı 2 yıl garantili,ABS Pa6 PRIME hammaddeden üretilmiştir.

Şemsiyenin orta borusu2 parçadan oluşmaktadır.

Şemsiyede kullanılan alt boru Ø39x41 mm. üst boru ise Ø35.8x38.2 mm.'dir.

Şemsiye alt ve üst boruların üzerindeki sıkma sistemi ile sabitlenerek istenilen yükseklik ayarlanabilir.

Şemsiyenin açma-kapama sistemi,kolları birbirine bağlayan orta plastiğin yukarı doğru sürülerek açılması sağlanır.

Orta plastiğin aşağı doğru çekilmesiyle kapanır.

Polyester,plastiteks,jüt kumaş seçeneğiyle etekli ve eteksiz olarak tercih edilebilir.

Bu ürünlerde orta boruya geçirilen sehpa ve küllük seçeneğiyle daha kullanışlı hale getirilebilir.

Uygun altlık seçenekleri alt bölümde gösterilmiştir.

It is an 4-arm, square umbrella made of aluminum that you can use in your garden,by the pool.

The umbrella body is covered with white electrostatic powder paint (RAL 9016).

All profiles used in the umbrella are 13x19 mm. and its wall thickness is 1.2 mm.

The plastic parts used in the umbrella are produced in our integrated facility and are guaranteed for 2 years against breakage, ABS Pa6 PRIME made from raw material.

The middle pipe of the umbrella consists of 2 parts.

The lower pipe used in the umbrella is Ø39x41 mm. the upper pipe is Ø35.8x38.2 mm.

The desired height can be adjusted by fixing the umbrella with the fixing system on the upper and lower pipes.

The opening-closing system of the umbrella allows the middle plastic connecting the arms to be opened by sliding upwards.

It closes by pulling it down.

It can be preferred with or without skirt, with polyester, plastic, jute fabric options.

These products can be made more useful with the option of a coffee table and ashtray attached to the middle pipe.

Suitable pad options are shown in the lower section.

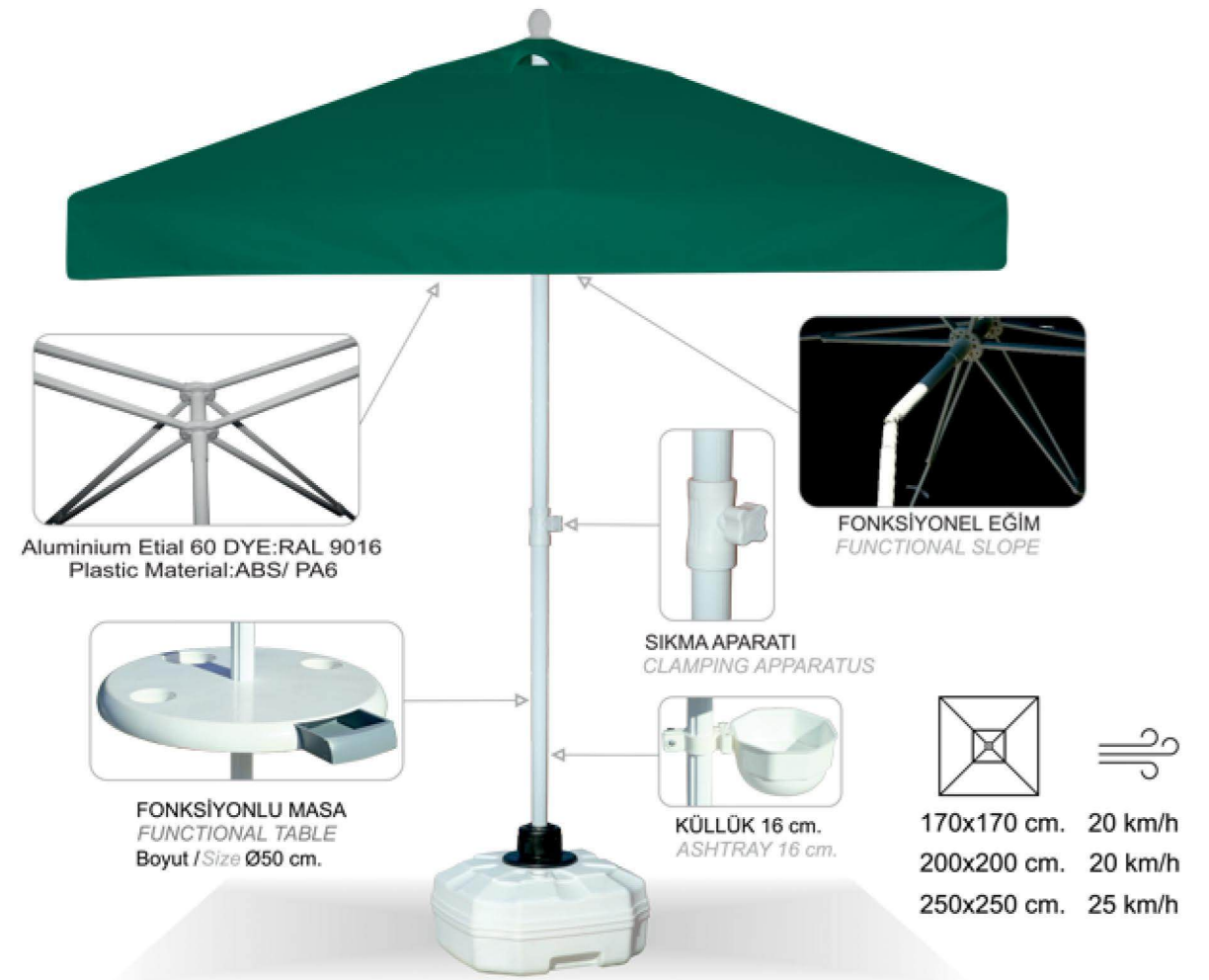

ÖLÇÜLER / SIZES

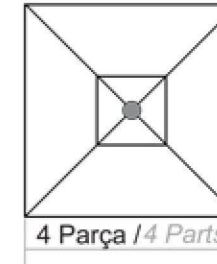

BLS 170x170/4	170x170 cm.
BLS 200x200/4	200x200 cm.
BLS 250x250/4	250x250 cm.

TEKNİK ÖZELLİKLER

TECHNICAL SPECIFICATIONS

KOD CODE	KAPLI ALAN AREA COVERED	AĞIRLIK WEIGHT	AMBALAJ PACKAGING	AMBALAJ PACKAGING
	m ²	kg.	1 ad./pcs.	4 ad./pcs.
BLS 170x170/4	3	5	15x15x160 cm.	27x27x160 cm.
BLS 200x200/4	4	7	15x15x160 cm.	27x27x160 cm.
BLS 250x250/4	6	8	15x15x230 cm.	27x27x215 cm.

PROFİLLER / PROFILES

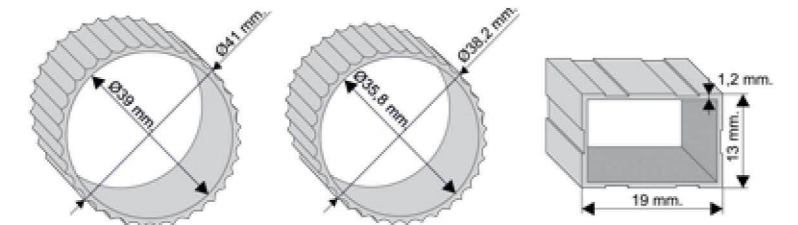
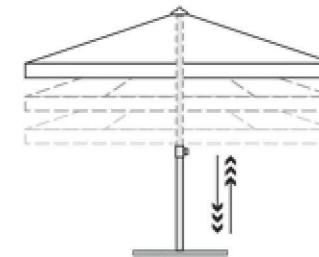

ALTIKLAR / BASES



TKN-301 50x50 cm./ 80 kg.



TKN-W-1040



TKN-LUX-3010 50 kg
BETONLU/CONCRETE

Altlıklar fiyatlara dahil değildir.
Bases are not included in the price.



SHADOW

SHADOW YUVARLAK

SHADOW ROUND



Bahçenizde, havuz kenarında kullanabileceğiniz 8 kollu, alüminyumdan üretilmiş yuvarlak şekilde şemsiyedir.

Beyaz renkli elektrostatik boya (RAL 9016) ile kaplanarak üretilen şemsiyenin orta borusu Ø 40 mm.'dir.

İskelette bulunan plastik parçalar, tüm dünyada şemsiye üretiminde kullanılan kırılmaya karşı 2 yıl garantili ABS ve POLYAMID

Pa6 PRIME hammadde kullanılarak üretilmiştir.

Şemsiyenin rüzgar tahliyesi tepe kısmında bulunan hava pencereleri ile yapılabildiği için şemsiye rüzgarlı havalarda güvenle kullanılabilir.

Şemsiyeyi açmak için orta boru üzerinde bulunan plastik gövde mandalını bastırarak ve yukarı doğru hareket ettirerek

boruda bulunan yuvaya emniyet piminin otomatik olarak oturması yeterlidir.

Kapanması ise mandalın bastırılarak emniyet piminin yuvasından çıkması ile kolay bir şekilde yapılır.

Uygun altlıklar alt bölümde gösterilmiştir. Polyester-Jüt-Plastex veya Akrilik kumaş seçeneği ile sizi yıllarca güneşten koruyabilir.

It is an 8-arm, round umbrella made of aluminum that you can use in your garden, by the pool.

The middle pipe of the umbrella, which is produced by coating with white electrostatic paint (RAL 9016), is Ø 40 mm.

PLastic parts in the skeleton are ABS and POLYAMID with 2 years warranty against breakage, which are used in umbrella production all over the world.

It is produced using Pa6 PRIME raw material.

Since the wind evacuation of the umbrella can be done with the air windows on the top, the umbrella can be used safely in windy weather.

Pressing the plastic body latch on the middle pipe and moving it upwards to open the umbrella

It is sufficient that the safety pin automatically fits into the slot in the pipe.

Closing is done easily by pressing the latch and removing the safety pin from its slot.

Suitable underlays are shown in the lower section. Polyester-Jute-Plastex or Acrylic fabric options can protect you from the sun for years.

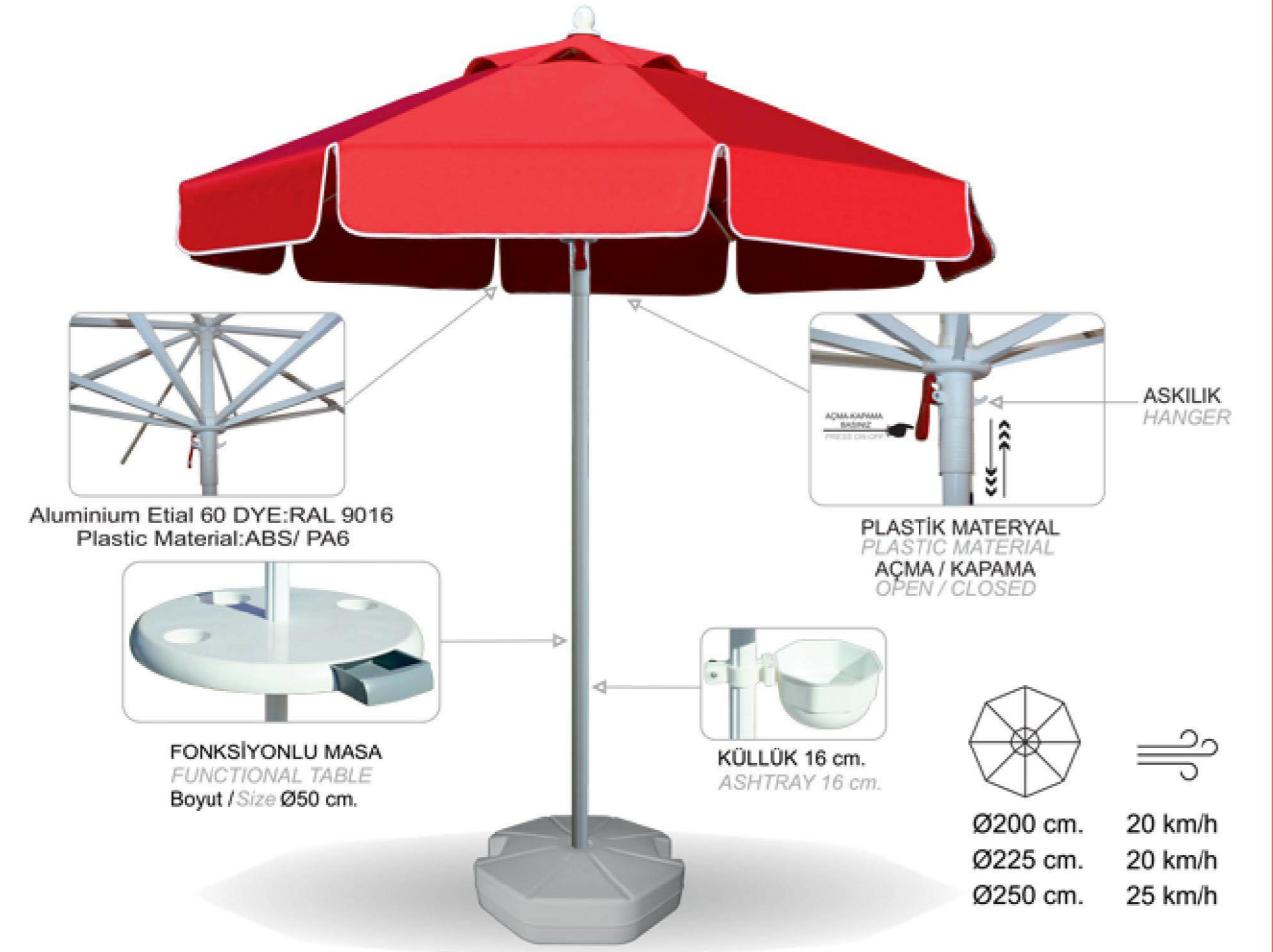

ÖLÇÜLER / SIZES

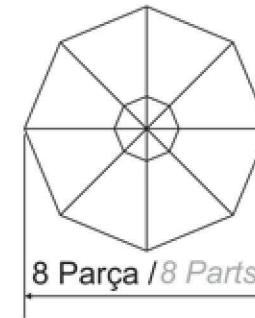

SMR 200/8....Ø200 cm.

SMR 225/8....Ø225 cm.

SMR 250/8....Ø250 cm.

TEKNİK ÖZELLİKLER

TECHNICAL SPECIFICATIONS

KOD CODE	KAPLI ALAN AREA COVERED	AĞIRLIK WEIGHT	AMBALAJ PACKAGING	AMBALAJ PACKAGING
	m ²	Kg.	1 ad./pcs.	4 ad./pcs.
SMR 200/8	3	10	15x15x230cm.	27x27x240cm.
SMR 225/8	4	11	15x15x230cm.	27x27x240cm.
SMR 250/8	5	12	15x15x230cm.	27x27x240cm.

PROFİLLER / PROFILES

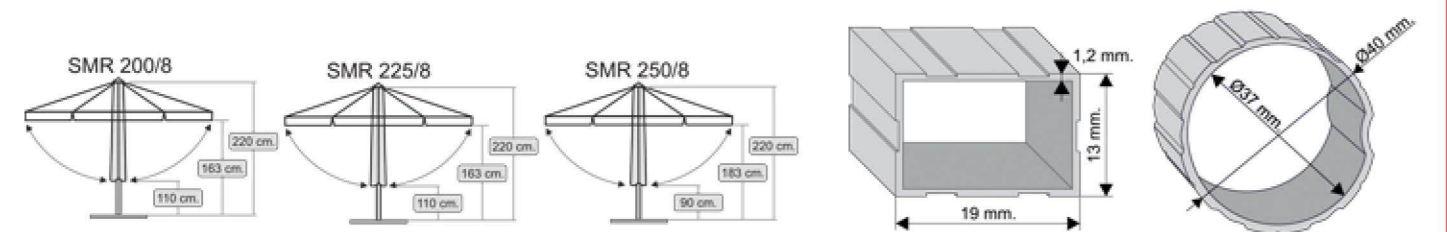

ALTLIKLAR / BASES



Altlıklar fiyatlara dahil değildir.
Bases are not included in the price.

SHADOW KARE SHADOW SQUARE



Bahçenizde,havuz kenarında kullanabileceğiniz 4 veya 8 kollu,alüminyumdan üretilmiş kare şeklinde şemsiyedir.

Beyaz renkli elektrostatik boya (RAL 9016) ile kaplanarak üretilen şemsiyenin orta borusu Ø 40 mm.'dir.

Iskelette bulunan plastik parçalar,tüm dünyada şemsiye üretiminde kullanılan kırılmaya karşı 2 yıl garantili ABS ve POLYAMID

Pa6 PRIME hammadde kullanılarak üretilmiştir.

Şemsiyenin rüzgar tahliyesi tepe kısmında bulunan hava pencereleri ile yapılabildiği için şemsiye rüzgarlı havalarda güvenle kullanılabilir.

Şemsiyeyi açmak için orta boru üzerinde bulunan plastik gövde mandalını bastırarak ve yukarı doğru hareket ettirerek

boruda bulunan yuvaya emniyet piminin otomatik olarak oturması yeterlidir.

Kapanması ise mandalın bastırılarak emniyet piminin yuvasından çıkması ile kolay bir şekilde yapılır.

Uygun altlıklar alt bölümde gösterilmiştir.Polyester-Jüt-Plastex veya Akırlık kumaş seçeneği ile sizi yıllarca güneşten koruyabilir.

It is an 4 and 8-arm, square umbrella made of aluminun that you can use in your garden,by the pool.

The middle pipe of the umbrella, which is produced by coating with white electrostatic paint (RAL 9016), is Ø 40 mm.

Plastic parts in the skeleton are ABS and POLYAMID with 2 years warranty against breakage, which are used in umbrella production all over the world.

It is produced using Pa6 PRIME raw material.

Since the wind evacuation of the umbrella can be done with the air windows on the top, the umbrella can be used safely in windy weather.

Pressing the plastic body latch on the middle pipe and moving it upwards to open the umbrella

It is sufficient that the safety pin automatically fits into the slot in the pipe.

Closing is done easily by pressing the latch and removing the safety pin from its slot.

Suitable underlays are shown in the lower section. Polyester-Jute-Plastex or Acrylic fabric options can protect you from the sun for years.

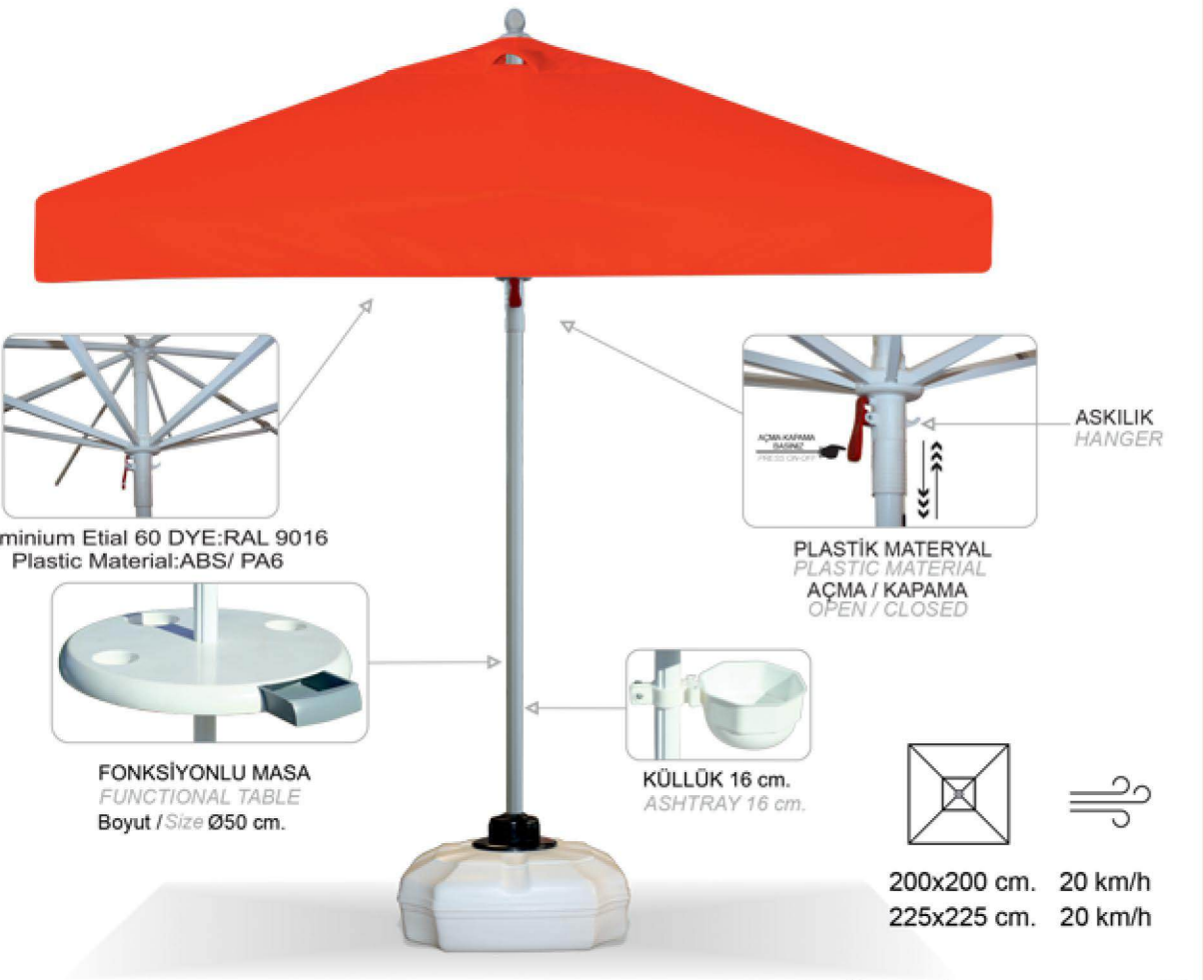

ÖLÇÜLER / SIZES

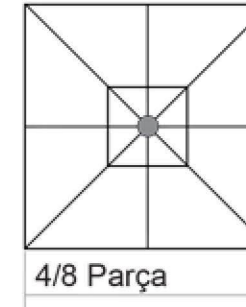

4/8 Parça

4/8 Parts

SMS 170x170/4....170x170 cm.

SMS 200x200/4....200x200 cm.

SMS 200x200/8....200x200 cm.

SMS 225x225/8....225x225 cm.

TEKNİK ÖZELLİKLER TECHNICAL SPECIFICATIONS

KAPLI ALAN AREA COVERED	AĞIRLIK WEIGHT	AMBALAJ PACKAGING	AMBALAJ PACKAGING
m ²	Kg.	1 ad./pcs.	4 ad./pcs.
3	10	15x15x230 cm.	27x27x240 cm.
4	11	15x15x230 cm.	27x27x240 cm.
4	12	15x15x230 cm.	27x27x240 cm.
5	13	15x15x230 cm.	27x27x240 cm.

PROFİLLER / PROFILES

SMS 170x170/4

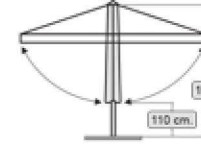

SMS 200x200/4

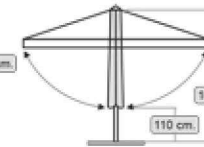

SMS 200x200/8

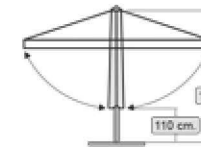

SMS 225x225/8

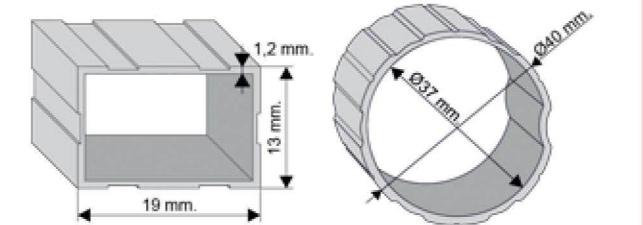
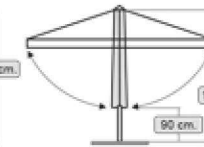

ALTILIKLAR / BASES



TKN-301 50x50 cm./ 80 kg.



TKN-W-1040



TKN-LUX-3010 50 kg
BETONLU/CONCRETE

Altlıklar fiyatlara dahil değildir.
Bases are not included in the price.



TEKİN ŞEMSIYE
Güvenle Açılan Şemsiye
— Since 1986 —

MAXI SHADOW

MAXI SHADOW YUVARLAK

MAXI SHADOW ROUND



Bahçenizde, havuz kenarında kullanabileceğiniz 8 kollu, alüminyumdan üretilmiş yuvarlak şekilde şemsiyedir.

Beyaz renkli elektrostatik boya (RAL 9016) ile kaplanarak üretilen şemsiyenin orta borusu Ø 50 mm.'dir.

İskelette bulunan plastik parçalar, tüm dünyada şemsiye üretiminde kullanılan kırılmaya karşı 2 yıl garantili ABS ve POLYAMID

Pa6 PRIME hammadde kullanılarak üretilmiştir.

Şemsiyenin rüzgar tahliyesi tepe kısmında bulunan hava pencereleri ile yapılabildiği için şemsiye rüzgarlı havalarda güvenle kullanılabilir.

Şemsiyeyi açmak için orta boru üzerinde bulunan plastik gövde mandalını bastırarak ve yukarı doğru hareket ettirerek

boruda bulunan yuvaya emniyet piminin otomatik olarak oturması yeterlidir.

Kapanması ise mandalın bastırılarak emniyet piminin yuvasından çıkması ile kolay bir şekilde yapılır.

Uygun altlıklar alt bölümde gösterilmiştir. Polyester-Jüt-Plastex veya Akriik kumaş seçeneği ile sizi yıllarca güneşten koruyabilir.

It is an 8-arm, round umbrella made of aluminum that you can use in your garden, by the pool.

The middle pipe of the umbrella, which is produced by coating with white electrostatic paint (RAL 9016), is Ø 50 mm.

Plastic parts in the skeleton are ABS and POLYAMID with 2 years warranty against breakage, which are used in umbrella production all over the world.

It is produced using Pa6 PRIME raw material.

Since the wind evacuation of the umbrella can be done with the air windows on the top, the umbrella can be used safely in windy weather.

Pressing the plastic body latch on the middle pipe and moving it upwards to open the umbrella

It is sufficient that the safety pin automatically fits into the slot in the pipe.

Closing is done easily by pressing the latch and removing the safety pin from its slot.

Suitable underlays are shown in the lower section. Polyester-Jute-Plastex or Acrylic fabric options can protect you from the sun for years.

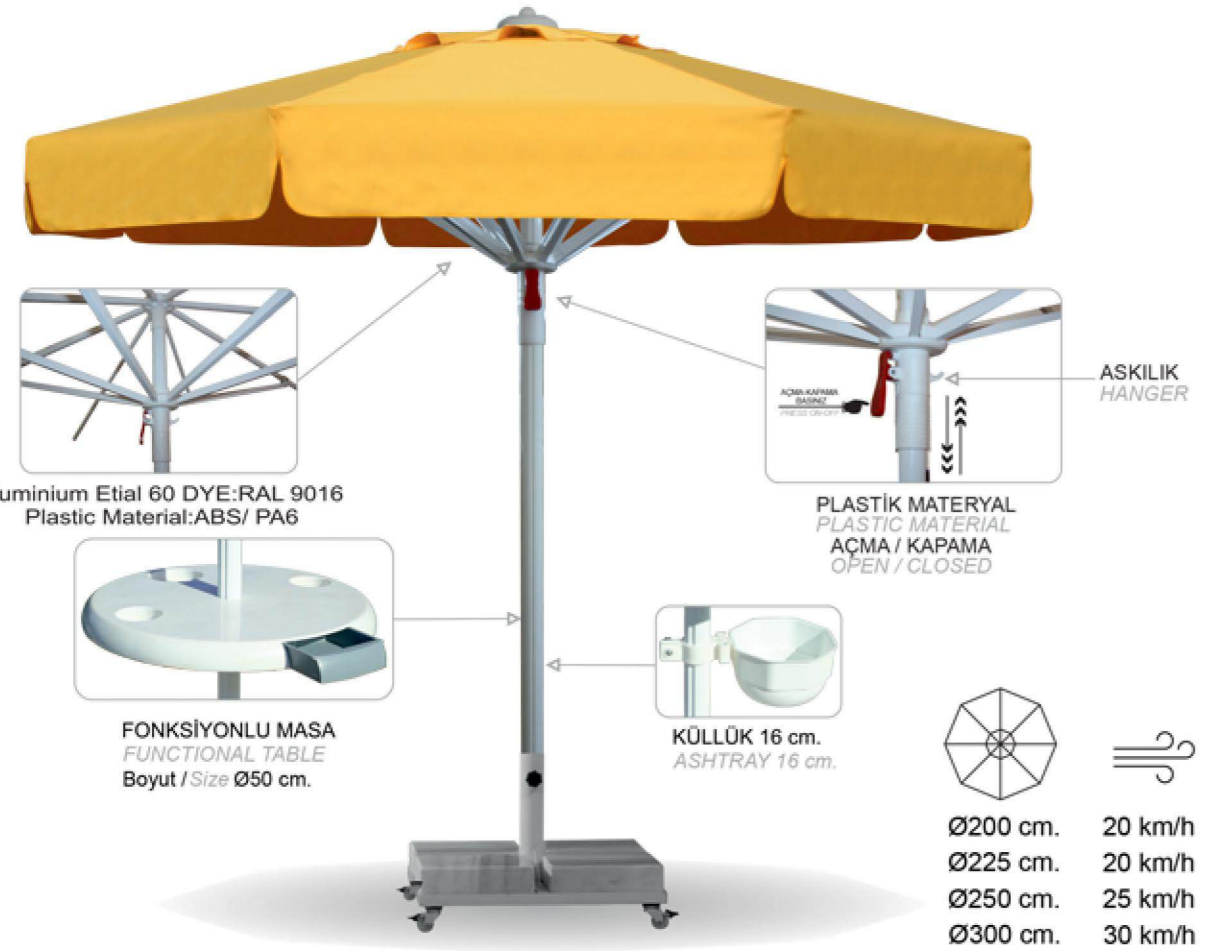

Aluminium Etial 60 DYE:RAL 9016
Plastic Material:ABS/ PA6

PLASTİK MATERYAL
PLASTIC MATERIAL
AÇMA / KAPAMA
OPEN / CLOSED

ASKILIK
HANGER

FONKSİYONLU MASA
FUNCTIONAL TABLE
Boyut / Size Ø50 cm.

KÜLLÜK 16 cm.
ASHTRAY 16 cm.

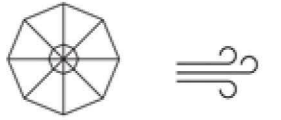

Ø200 cm. 20 km/h
Ø225 cm. 20 km/h
Ø250 cm. 25 km/h
Ø300 cm. 30 km/h

ÖLÇÜLER / SIZES

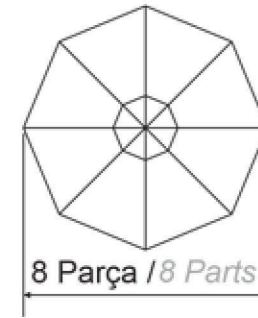

8 Parça / 8 Parts

MSMR 200/8....Ø200 cm.

MSMR 225/8....Ø225 cm.

MSMR 250/8....Ø250 cm.

MSMR 300/8....Ø300 cm.

TEKNİK ÖZELLİKLER

TECHNICAL SPECIFICATIONS

KOD CODE	KAPLI ALAN AREA COVERED	AĞIRLIK WEIGHT	AMBALAJ PACKAGING
	m ²	Kg.	1 ad./pcs.
MSMR 200/8	3	15	22x22x250 cm.
MSMR 225/8	4	15	22x22x250 cm.
MSMR 250/8	5	20	22x22x250 cm.
MSMR 300/8	6	23	22x22x250 cm.

PROFİLLER / PROFILES

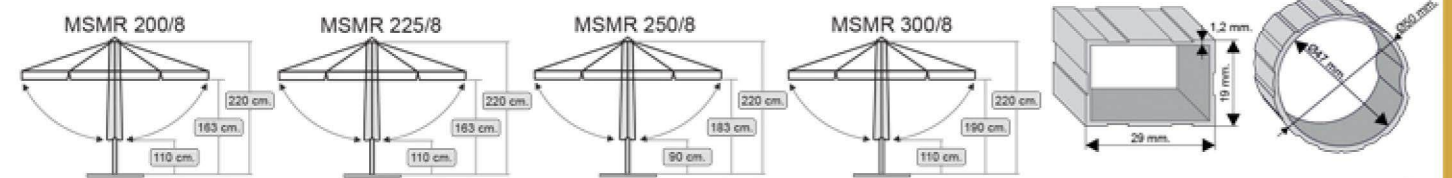

ALTLIKLAR / BASES



TKN -301
50x50 cm./ 80 kg.



TKN W-1050 75 lt./ BASE
Altlıklar fiyatlara dahil değildir.
Bases are not included in the price.



TEKERLEKLI
WHEELLED
TKN LUX-3010 50 kg
BETONLU/ CONCRETE

MAXI SHADOW KARE MAXI SHADOW SQUARE



Bahçenizde,havuz kenarında kullanabileceğiniz 4 veya 8 kollu,alüminyumdan üretilmiş kare şekilde şemsiyedir.

Beyaz renkli elektrostatik boya (RAL 9016) ile kaplanarak üretilen şemsiyenin orta borusu Ø 50 mm.'dir.

İskelette bulunan plastik parçalar,tüm dünyada şemsiye üretiminde kullanılan kırılmaya karşı 2 yıl garantili ABS ve POLYAMID

Pa6 PRIME hammadde kullanılarak üretilmiştir.

Şemsiyenin rüzgar tahliyesi tepe kısmında bulunan hava pencereleri ile yapılabildiği için şemsiye rüzgarlı havalarda güvenle kullanılabilir.

Şemsiyeyi açmak için orta boru üzerinde bulunan plastik gövde mandalını bastırarak ve yukarı doğru hareket ettirerek

boruda bulunan yuvaya emniyet piminin otomatik olarak oturması yeterlidir.

Kapanması ise mandalın bastırılarak emniyet piminin yuvasından çıkması ile kolay bir şekilde yapılır.

Uygun altlıklar alt bölümde gösterilmiştir.Polyester-Jüt-Plastex veya Akriлик kumaş seçeneği ile sizi yıllarca güneşten koruyabilir.

It is an 4 and 8-arm, square umbrella made of aluminum that you can use in your garden,by the pool.

The middle pipe of the umbrella, which is produced by coating with white electrostatic paint (RAL 9016), is Ø 50 mm.

Plastic parts in the skeleton are ABS and POLYAMID with 2 years warranty against breakage, which are used in umbrella production all over the world.

It is produced using Pa6 PRIME raw material.

Since the wind evacuation of the umbrella can be done with the air windows on the top, the umbrella can be used safely in windy weather.

Pressing the plastic body latch on the middle pipe and moving it upwards to open the umbrella

It is sufficient that the safety pin automatically fits into the slot in the pipe.

Closing is done easily by pressing the latch and removing the safety pin from its slot.

Suitable underlays are shown in the lower section. Polyester-Jute-Plastex or Acrylic fabric options can protect you from the sun for years.

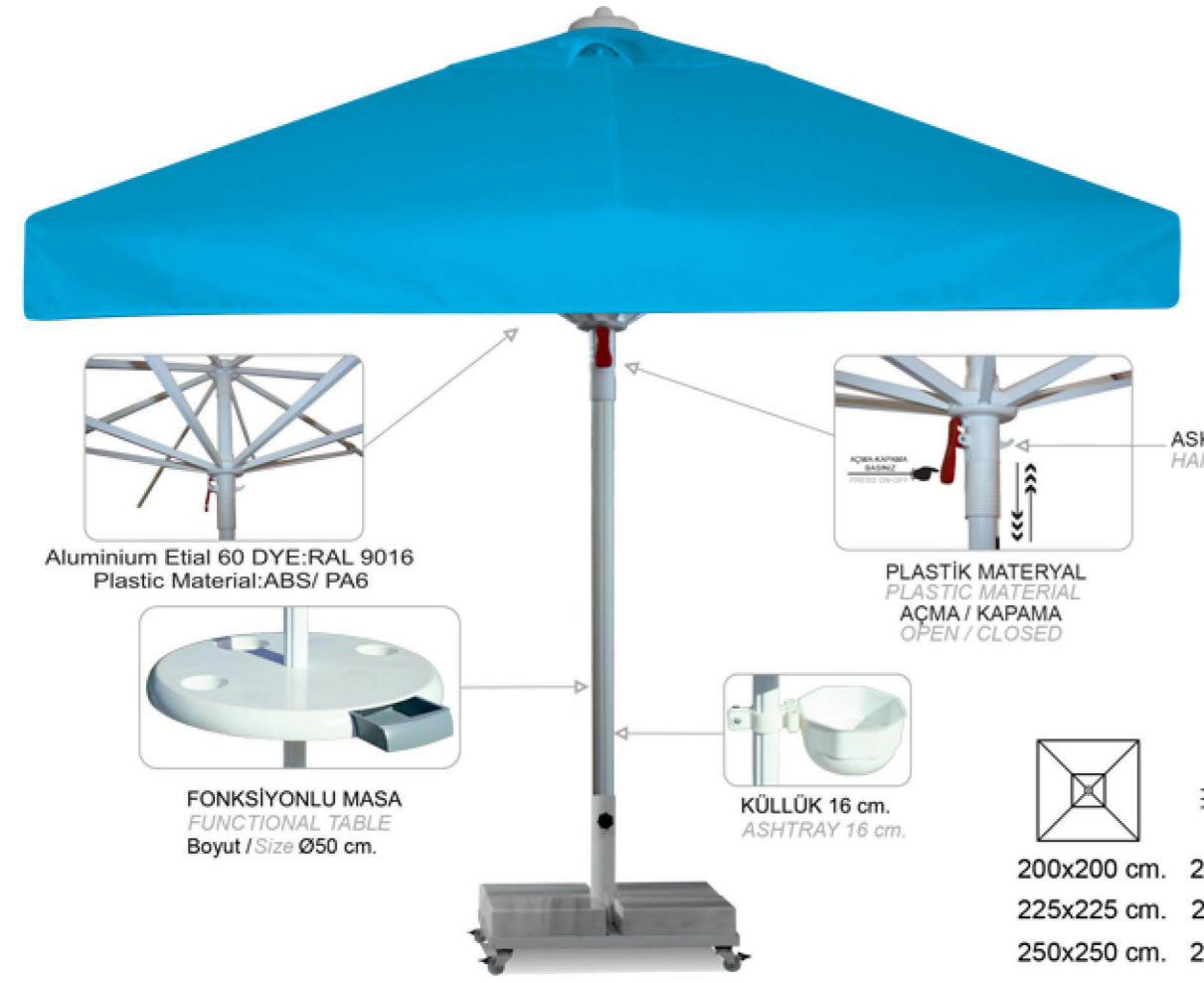

Aluminium Etial 60 DYE:RAL 9016
Plastic Material:ABS/ PA6

PLASTİK MATERYAL
PLASTIC MATERIAL
AÇMA / KAPAMA
OPEN / CLOSED

ASKILIK
HANGER

FONKSİYONLU MASA
FUNCTIONAL TABLE
Boyut / Size Ø50 cm.

KÜLLÜK 16 cm.
ASHTRAY 16 cm.

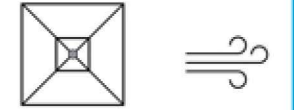

200x200 cm. 20 km/h
225x225 cm. 20 km/h
250x250 cm. 25 km/h

ÖLÇÜLER / SIZES

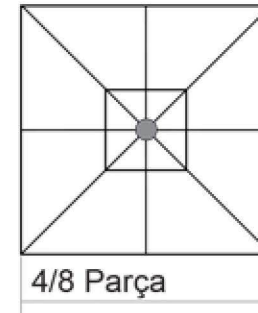

4/8 Parça

4/8 Parts

MSMS 200x200/4....200x200 cm.
MSMS 200x200/8....200x200 cm.
MSMS 225x225/8....225x225 cm.
MSMS 250x250/8....250x250 cm.

TEKNİK ÖZELLİKLER

TECHNICAL SPECIFICATIONS

KOD CODE	KAPLI ALAN AREA COVERED	AĞIRLIK WEIGHT	AMBALAJ PACKAGING
	m ²	Kg.	1 ad./pcs.
MSMS 200x200/4	4	12	22x22x250 cm.
MSMS 200x200/8	4	13	22x22x250 cm.
MSMS 225x225/8	5	20	22x22x260 cm.
MSMS 250x250/8	6,25	23	22x22x260 cm.

PROFİLLER / PROFILES

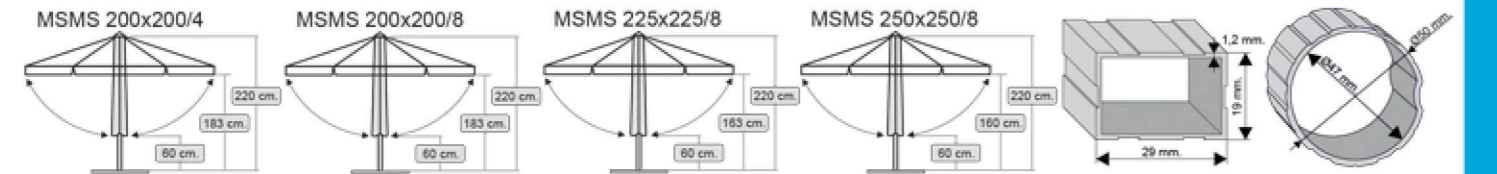

ALTLIKLAR / BASES



TKN-301
50x50 cm./ 80 kg.



TKN-W-1050 75 lt./BASE

Altlıklar fiyatlara dahil değildir.

Bases are not included in the price.



TKN-LUX-3010 50 kg
BETONLU/CONCRETE



TEKİN ŞEMSIYE®
Güvenle Açılan Şemsiye
— Since 1986 —

ROPE

ROPE YUVARLAK ROPE ROUND



Bahçenizde,havuz kenarında,cafe veya restaurantlarda kullanabileceğiniz 8 kollu,alüminyumdan üretilmiş yuvarlak şekildedeki şemsiyedir.

Beyaz renkli elektrostatik boya (RAL 9016) veya eloksal kaplamalı olarak üretilen şemsiyenin orta borusu Ø 50 mm.'dir.

İskelette bulunan plastik parçalar,tüm dünyada şemsiye üretiminde kullanılan kırılmaya karşı 2 yıl garantili ABS ve POLYAMID Pa6 PRIME hammadde kullanılarak üretilmiştir.

Şemsiyenin rüzgar tahliyesi tepe kısmında bulunan hava kanalları ile veya tercihe göre kule sistemi olarak yapılabildiği için,rüzgarlı havalarda güvenle kullanılabilir.

Şemsiyeyi açmak için orta boru üzerinde bulunan ipi aşağı doğru çekilerek ve şemsiye tam olarak açıldığında emniyet plastiğine ipi sabitlemek yeterlidir.Ipi serbest bırakınca kolay bir şekilde kapatılır.

Uygun altlıklar alt bölümde gösterilmiştir.Polyester-Jüt-Plastex veya Akrilik kumaş seçeneği ile sizi yıllarca güneşten koruyabilir.

It is a round shaped umbrella made of aluminum with 8 arms that you can use in your garden, by the pool, in cafes or restaurants.

The middle pipe of the umbrella, which is produced with white electrostatic paint (RAL 9016) or anodized coating, is Ø 50 mm.

Plastic parts in the skeleton are ABS and POLYAMID with 2-year warranty against breakage, which are used in umbrella production all over the world.

It is produced using Pa6 PRIME raw material.

Since the wind evacuation of the umbrella can be done with the air ducts on the top or as a tower system, windy can be used safely in the weather.

To open the umbrella, pull the rope on the middle pipe downwards and when the umbrella is fully opened, the safety plastic

It is enough to fix the rope. When you release the rope, it is easily closed.

Suitable bases are shown in the lower section. Polyester-Jute-Plastex or Acrylic fabric options can protect you from the sun for years

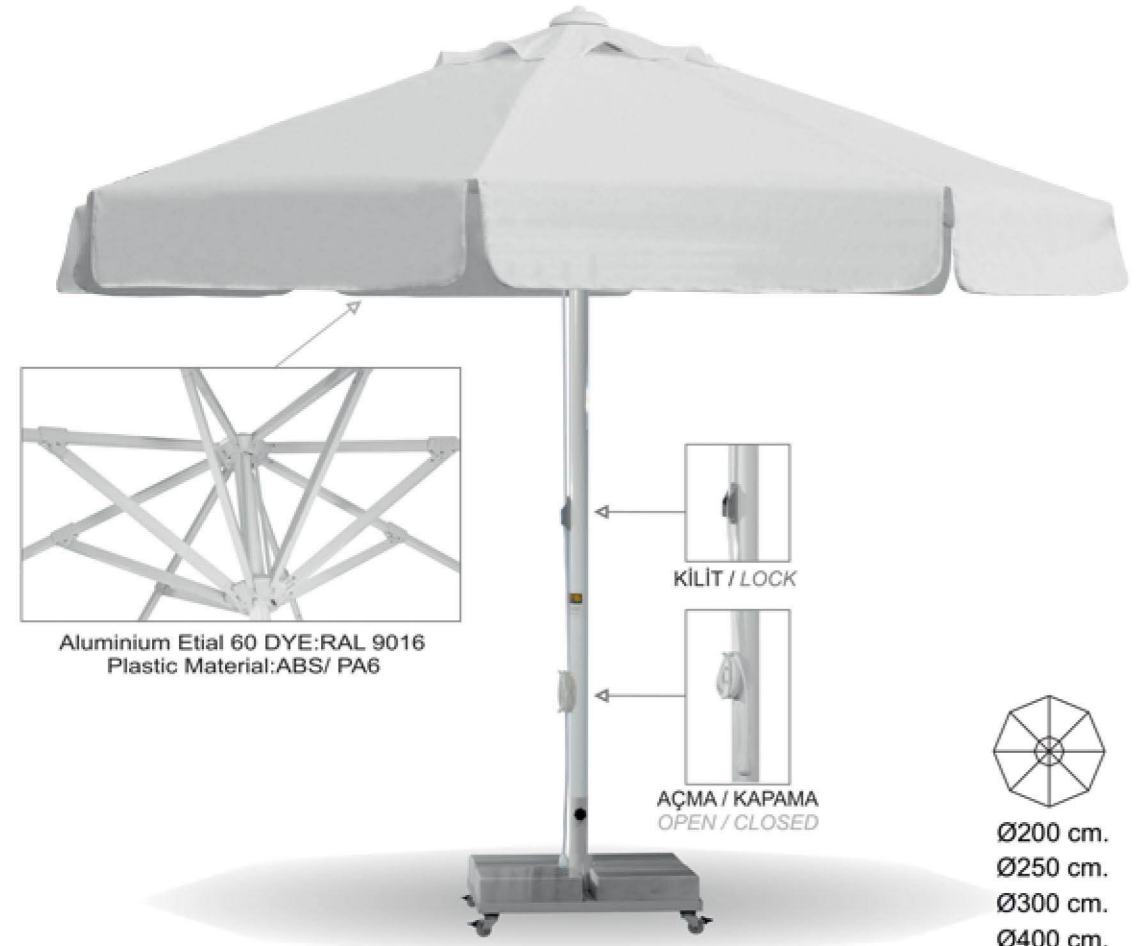

Ø200 cm.	20 km/h
Ø250 cm.	25 km/h
Ø300 cm.	30 km/h
Ø400 cm.	25 km/h
Ø500 cm.	30 km/h

ÖLÇÜLER / SIZES

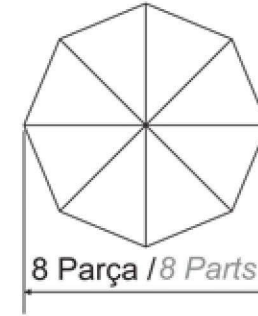

BR 200/8....Ø200 cm.
BR 250/8....Ø250 cm.
BR 300/8....Ø300 cm.
BR 400/8....Ø400 cm.
BR 500/8....Ø500 cm.

TEKNİK ÖZELLİKLER TECHNICAL SPECIFICATIONS

KOD CODE	KAPLI ALAN AREA COVERED	AĞIRLIK WEIGHT	AMBALAJ PACKAGING
	m ²	Kg.	1 ad./pcs.
BR 200/8	3	10	22x22x250 cm.
BR 250/8	5	12	22x22x250 cm.
BR 300/8	7	13	22x22x250 cm.
BR 400/8	12,5	20	22x22x250 cm.
BR 500/8	20	23	22x22x250 cm.

PROFİLLER / PROFILES

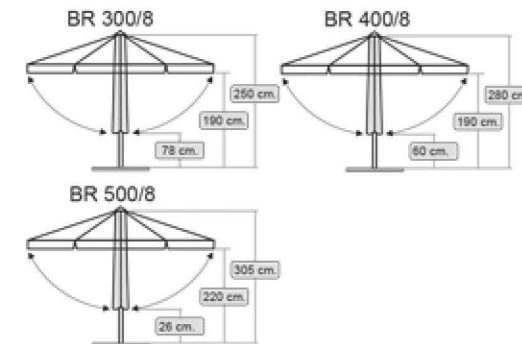
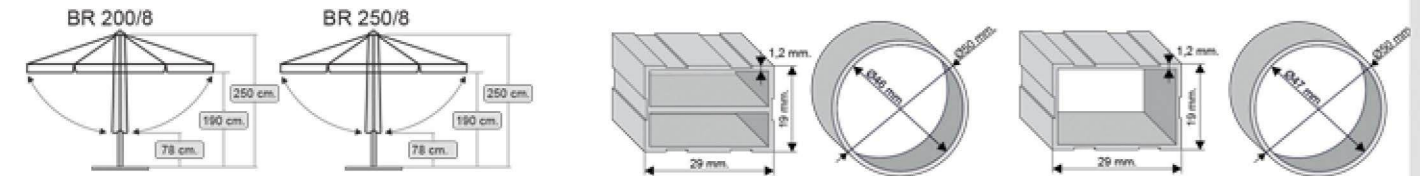

ALTLIKLAR / BASES



Altlıklar fiyatlara dahil değildir.
Bases are not included in the price.

ROPE KARE ROPE SQUARE



Bahçenizde,havuz kenarında,cafe veya restaurantlarda kullanabileceğiniz 8 kollu,alüminyumdan üretilmiş kare şekilde şemsiyedir.

Beyaz renkli elektrostatik boya (RAL 9016) veya eloksal kaplamalı olarak üretilen şemsiyenin orta borusu Ø 50 mm.'dir.

İskelette bulunan plastik parçalar,tüm dünyada şemsiye üretiminde kullanılan kırılmaya karşı 2 yıl garantili ABS ve POLYAMID

Pa6 PRIME hammadde kullanılarak üretilmiştir.

Şemsiyenin rüzgar tahliyesi tepe kısmında bulunan hava kanalları ile veya tercihe göre kule sistemi olarak yapılabildiği için,rüzgarlı

havalarda güvenle kullanılabilir.

Şemsiyeyi açmak için orta boru üzerinde bulunan ipi aşağı doğru çekilerek ve şemsiye tam olarak açıldığında emniyet plastiğine

ipi sabitlemek yeterlidir.İpi serbest bırakınca kolay bir şekilde kapatılır.

Uygun altlıklar alt bölümde gösterilmiştir.Polyester-Jüt-Plastex veya Akriklik kumaş seçeneği ile sizi yıllarca güneşten koruyabilir.

It is a square shaped umbrella made of aluminum with 8 arms that you can use in your garden, by the pool, in cafes or restaurants.

The middle pipe of the umbrella, which is produced with white electrostatic paint (RAL 9016) or anodized coating, is Ø 50 mm.

Plastic parts in the skeleton are ABS and POLYAMID with 2-year warranty against breakage, which are used in umbrella production all over the world.

It is produced using Pa6 PRIME raw material.

Since the wind evacuation of the umbrella can be done with the air ducts on the top or as a tower system, windy can be used safely in the weather.

To open the umbrella, pull the rope on the middle pipe downwards and when the umbrella is fully opened, the safety plastic

It is enough to fix the rope. When you release the rope, it is easily closed.

Suitable bases are shown in the lower section. Polyester-Jute-Plastex or Acrylic fabric options can protect you from the sun for years

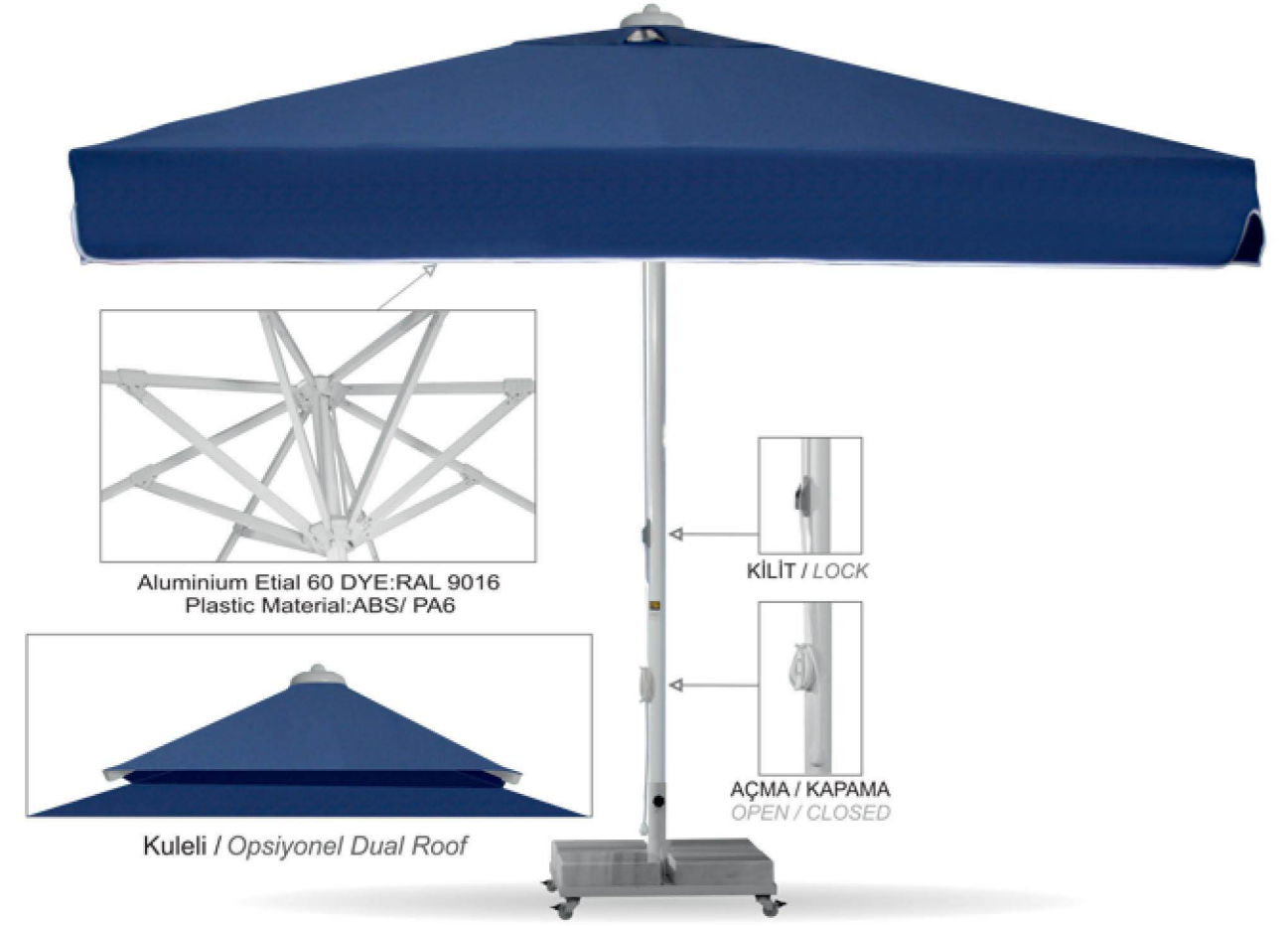

ÖLÇÜLER / SIZES

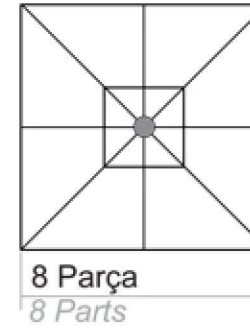

BS 200x200/8....200x200 cm.
BS 250x250/8....250x250 cm.
BS 300x300/8....300x300 cm.
BS 350x350/8....350x350 cm.
BS 400x400/8....400x400 cm.

TEKNİK ÖZELLİKLER TECHNICAL SPECIFICATIONS

KOD CODE	KAPLI ALAN AREA COVERED	AĞIRLIK WEIGHT	AMBALAJ PACKAGING
	m ²	Kg.	1 ad./pcs.
BS 200x200/8	4	12	22x22x250 cm.
BS 250x250/8	6,25	13	22x22x270 cm.
BS 300x300/8	9	20	22x22x280 cm.
BS 350x350/8	12,2	22	22x22x300 cm.
BS 400x400/8	16	25	22x22x335 cm.

PROFİLLER / PROFILES

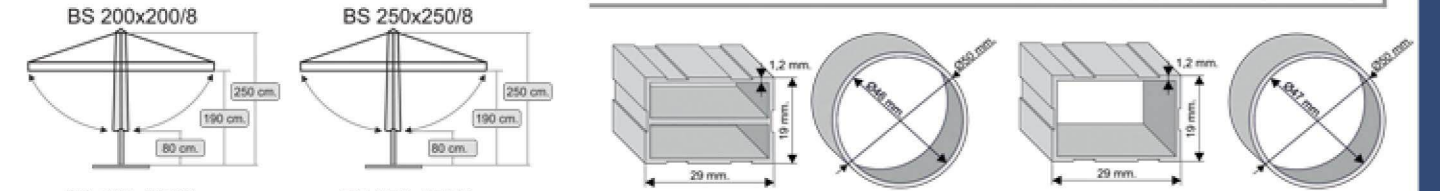

FEDERLİ
350x350/8-400x400/8'de kullanılır
Used on 350x350/8-400x400/8

ALTIKLAR / BASES



Altlıklar fiyatlara dahil değildir.
Bases are not included in the price.



MAXI ROPE

MAXI ROPE YUVARLAK

MAXI ROPE ROUND

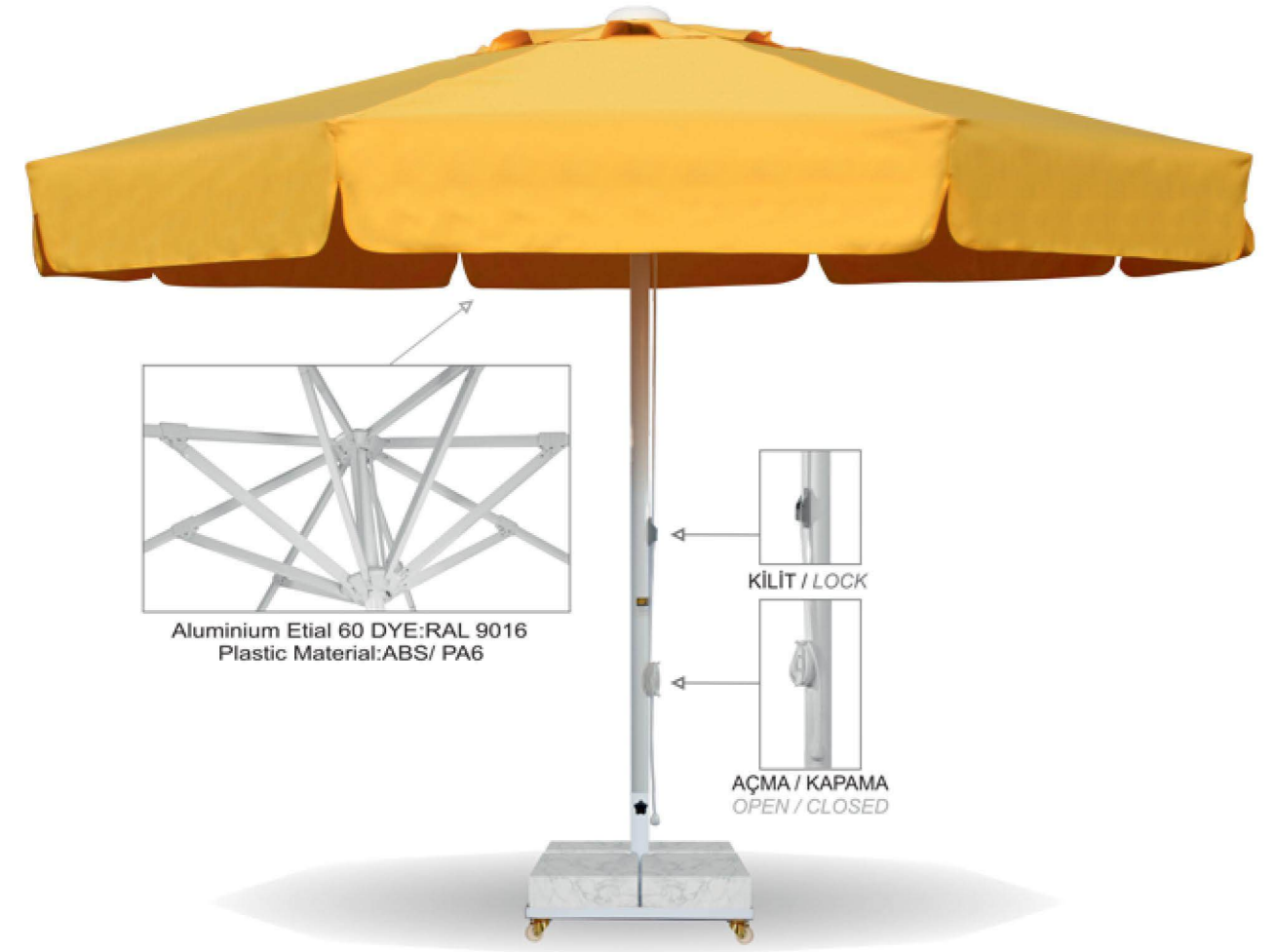

Bahçenizde,havuz kenarında,cafe veya restaurantlarda kullanabileceğiniz 8 kollu,alüminyumdan üretilmiş yuvarlak şekilde şemsiyedir.

Beyaz renkli elektrostatik boya (RAL 9016) veya eloksal kaplamalı olarak üretilen şemsiyenin orta borusu Ø 60 mm.'dir.

İskelette bulunan plastik parçalar,tüm dünyada şemsiye üretiminde kullanılan kırılmaya karşı 2 yıl garantili ABS ve POLYAMID

Pa6 PRIME hammadde kullanılarak üretilmiştir.

Şemsiyenin rüzgar tahliyesi tepe kısmında bulunan hava kanalları ile veya tercihe göre kule sistemi olarak yapılabildiği için,rüzgarlı havalarda güvenle kullanılabilir.

Şemsiyeyi açmak için orta boru üzerinde bulunan ipi aşağı doğru çekilerek ve şemsiye tam olarak açıldığında emniyet plastiğine ipi sabitlemek yeterlidir.İpi serbest bırakınca kolay bir şekilde kapatılır.

Uygun altlıklar alt bölümde gösterilmiştir.Polyester-Jüt-Plastex veya Akrilik kumaş seçeneği ile sizi yıllarca güneşten koruyabilir.

It is an 8-arm, round umbrella made of aluminum that you can use in your garden, by the pool, in cafes or restaurants.

The middle pipe of the umbrella, which is produced with white electrostatic paint (RAL 9016) or anodized coating, is Ø 60 mm.

Plastic parts in the skeleton, ABS and POLYAMID with 2-year warranty against breakage, which are used in umbrella production all over the world.

It is produced using Pa6 PRIME raw material.

Since the wind evacuation of the umbrella can be done with the air ducts on the top or as a tower system, windy can be used safely in the weather.

To open the umbrella, pull the rope on the middle pipe downwards and when the umbrella is fully opened, the safety plastic

It is enough to fix the rope. When you release the rope, it is easily closed.

Suitable underlays are shown in the lower section. Polyester-Jute-Plastex or Acrylic fabric options can protect you from the sun for years.

ÖLÇÜLER / SIZES

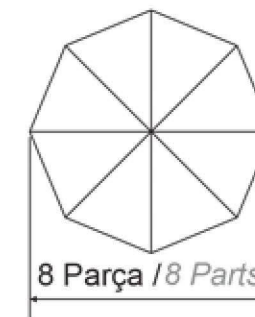

MBR 300/8...Ø300 cm.

MBR 400/8...Ø400 cm.

MBR 500/8...Ø500 cm.

TEKNİK ÖZELLİKLER

TECHNICAL SPECIFICATIONS

KOD CODE	KAPLI ALAN AREA COVERED	AĞIRLIK WEIGHT	AMBALAJ PACKAGING
	m ²	Kg.	1 ad./pcs.
MBR 300/8	7	13	22x22x250 cm.
MBR 400/8	12,5	20	22x22x280 cm.
MBR 500/8	20	23	22x22x305 cm.

PROFİLLER / PROFILES

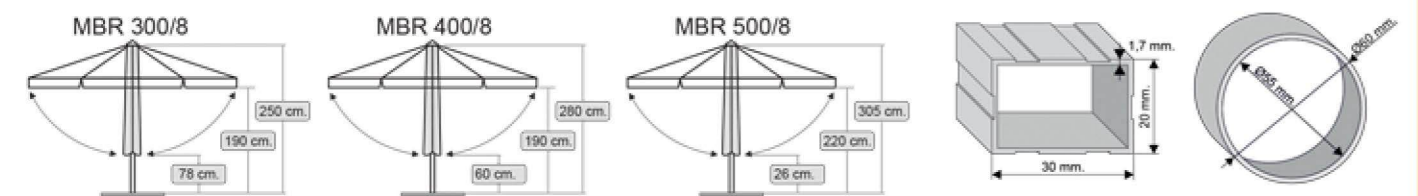

ALTLIKLAR / BASES

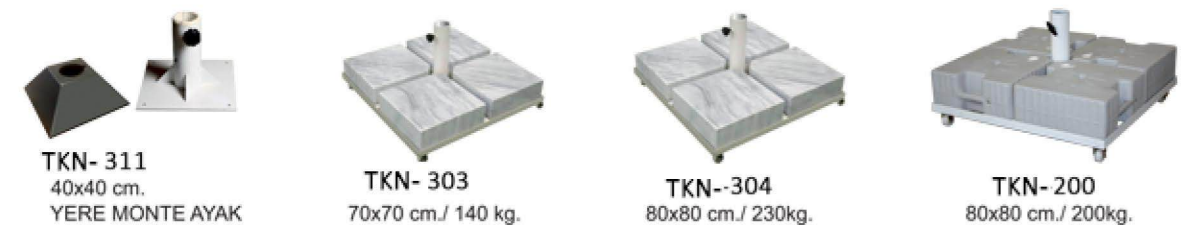

TKN- 311
40x40 cm.
YERE MONTE AYAK

TKN- 303
70x70 cm./ 140 kg.

TKN- 304
80x80 cm./ 230kg.

TKN- 200
80x80 cm./ 200kg.

Altlıklar fiyatlara dahil değildir.
Bases are not included in the price.

MAXI ROPE KARE MAXI ROPE ROUND



Bahçenizde,havuz kenarında,cafe veya restaurantlarda kullanabileceğiniz 8 kollu,alüminyumdan üretilmiş kare şekilde şemsiyedir.

Beyaz renkli elektrostatik boya (RAL 9016) veya eloksal kaplamalı olarak üretilen şemsiyenin orta borusu Ø 60 mm.'dir.

İskelette bulunan plastik parçalar,tüm dünyada şemsiye üretiminde kullanılan kırılmaya karşı 2 yıl garantili ABS ve POLYAMID

Pa6 PRIME hammadde kullanılarak üretilmiştir.

Şemsiyenin rüzgar tahliyesi tepe kısmında bulunan hava kanalları ile veya tercihe göre kule sistemi olarak yapılabildiği için,rüzgarlı havalarda güvenle kullanılabilir.

Şemsiyeyi açmak için orta boru üzerinde bulunan ipi aşağı doğru çekilerek ve şemsiye tam olarak açıldığında emniyet plastiğine ipi sabitlemek yeterlidir.İpi serbest bırakınca kolay bir şekilde kapatılır.

Uygun altlıklar alt bölümde gösterilmiştir.Polyester-Jüt-Plastex veya Akriik kumaş seçeneği ile sizi yıllarca güneşten koruyabilir.

It is an 8-arm, square umbrella made of aluminum that you can use in your garden, by the pool, in cafes or restaurants.

The middle pipe of the umbrella, which is produced with white electrostatic paint (RAL 9016) or anodized coating, is Ø 60 mm.

Plastic parts in the skeleton, ABS and POLYAMID with 2-year warranty against breakage, which are used in umbrella production all over the world.

It is produced using Pa6 PRIME raw material.

Since the wind evacuation of the umbrella can be done with the air ducts on the top or as a tower system, windy can be used safely in the weather.

To open the umbrella, pull the rope on the middle pipe downwards and when the umbrella is fully opened, the safety plastic

It is enough to fix the rope. When you release the rope, it is easily closed.

Suitable underlays are shown in the lower section. Polyester-Jute-Plastex or Acrylic fabric options can protect you from the sun for years.

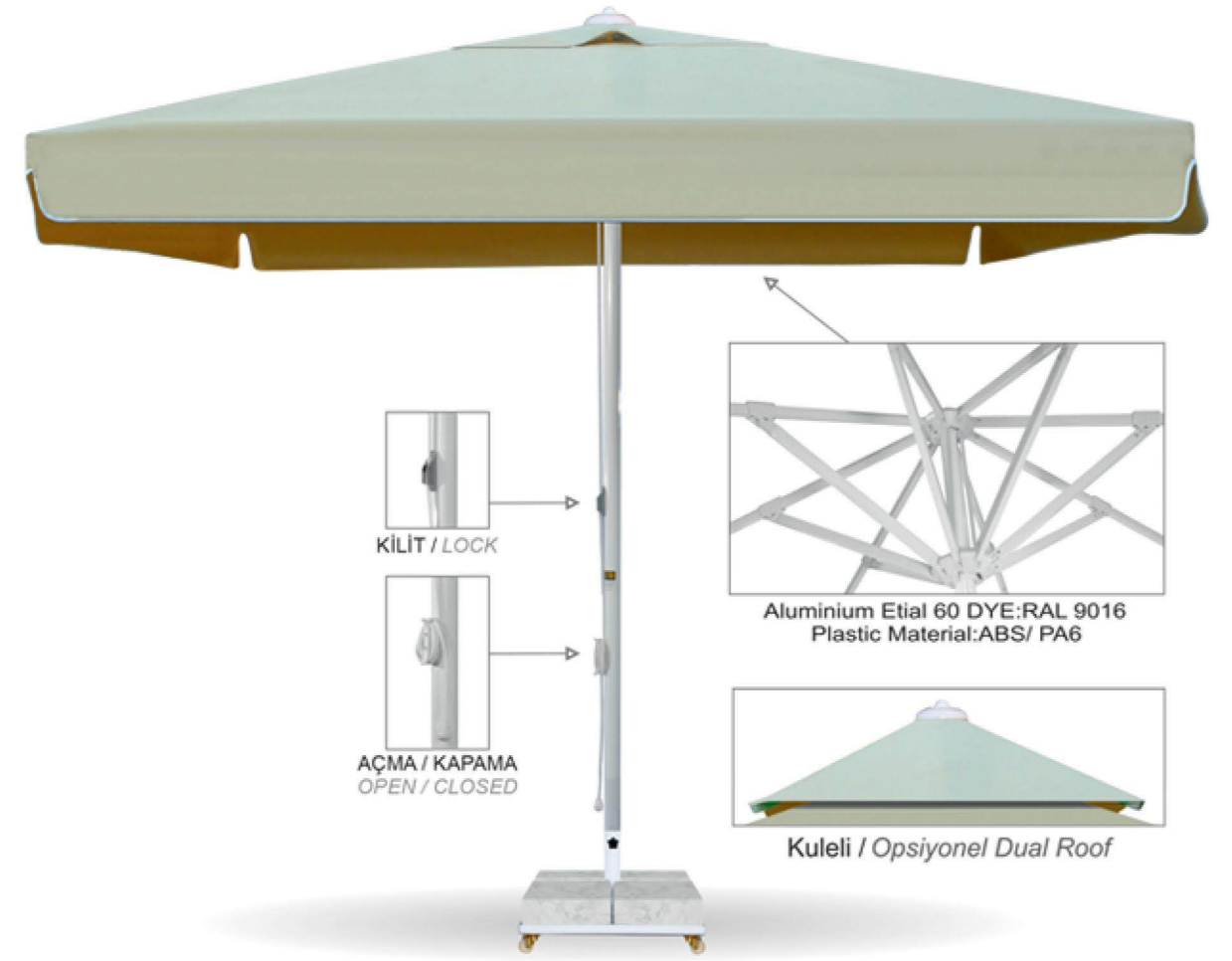

ÖLÇÜLER / SIZES

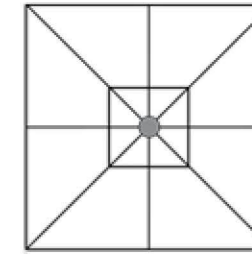

MBS 300x300/8....300x300 cm.

MBS 350x350/8....350x350 cm.

MBS 400x400/8....400x400 cm.

8 Parça
8 Parts

TEKNİK ÖZELLİKLER TECHNICAL SPECIFICATIONS

KOD CODE	KAPLI ALAN AREA COVERED	AĞIRLIK WEIGHT	AMBALAJ PACKAGING
	m ²	Kg.	1 ad./pcs.
MBS 300x300/8	9	13	22x22x280 cm.
MBS 350x350/8	12,2	20	22x22x300 cm.
MBS 400x400/8	16	23	22x22x335 cm.

PROFİLLER / PROFILES

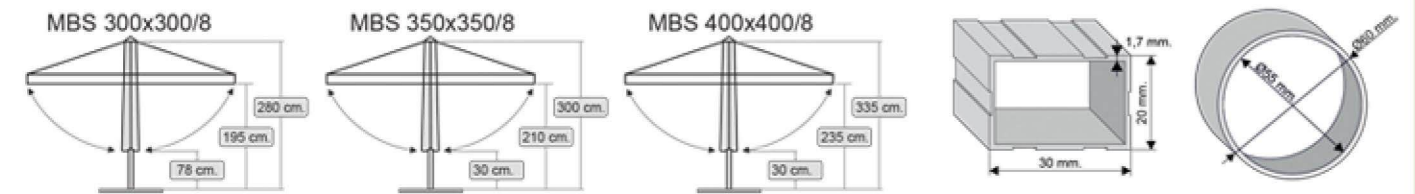

ALTLIKLAR / BASES



TKN- 311
40x40 cm.
YERE MONTE AYAK



TKN- 303
70x70 cm./ 140 kg.



TKN- 304
80x80 cm./ 230kg.



TKN- 200
80x80 cm./ 200kg.

Altlıklar fiyatlara dahil değildir.
Bases are not included in the price.



MANUEL TELESKOPIK

MANUEL TELESKOPIK YUVARLAK

MANUEL TELESCOPIC ROUND



Cafe,restaurant ve havuz kenarı kullanımına uygun üretilmiştir.8 kolu,alüminyumdan üretilmiş yuvarlak şekilde şemsiyedir.

Beyaz renkli elektrostatik boya (RAL 9016) kaplamalı olarak üretilen şemsiyenin orta borusu Ø 60 mm.'dir.

İskelette kullanılan plastik parçalar,tüm dünyada şemsiye üretiminde kullanılan kırılmaya karşı 2 yıl garantili ABS ve POLYAMID

Pa6 PRIME hammadde kullanılarak üretilmiştir.

Şemsiyenin rüzgar tahliyesi tepe kısmında bulunan hava kanalları ile veya tercihe göre kule sistemi olarak yapılabildiği için,rüzgarlı havalarda güvenle kullanılabilir.

Şemsiyeyi açmak için orta boru üzerinde bulunan mekanizmanın mandal kısmına bastırarak yukarı doğru hareket ettirilir, emniyet piminin orta boruda bulunan yuvasına girmesi sağlanır.Kapatmak için mandalı bastırarak emniyet piminin yuvasından çıkması sağlanır.

Uygun altlıklar alt bölümde gösterilmiştir.Polyester-Jüt-Plastex veya Akrilik kumaş seçeneği ile sizi yıllarca güneşten koruyabilir.

It is produced for cafe, restaurant and pool use. It is a round umbrella with 8 arms and made of aluminum.

The middle pipe of the umbrella, which is produced with white electrostatic paint (RAL 9016) coating, is Ø 60 mm.

Plastic parts used in the skeleton, ABS and POLYAMID with 2 years warranty against breakage used in umbrella production all over the world.

It is produced using Pa6 PRIME raw material.

Since the wind evacuation of the umbrella can be done with the air ducts on the top or as a tower system, windy can be used safely in the weather.

To open the umbrella, it is moved upwards by pressing the latch part of the mechanism on the middle pipe

It is ensured that the safety pin is inserted into its slot in the middle pipe. The safety pin is removed from its slot by pressing the latch to close.

Suitable underlays are shown in the lower section. Polyester-Jute-Plastex or Acrylic fabric options can protect you from the sun for years.

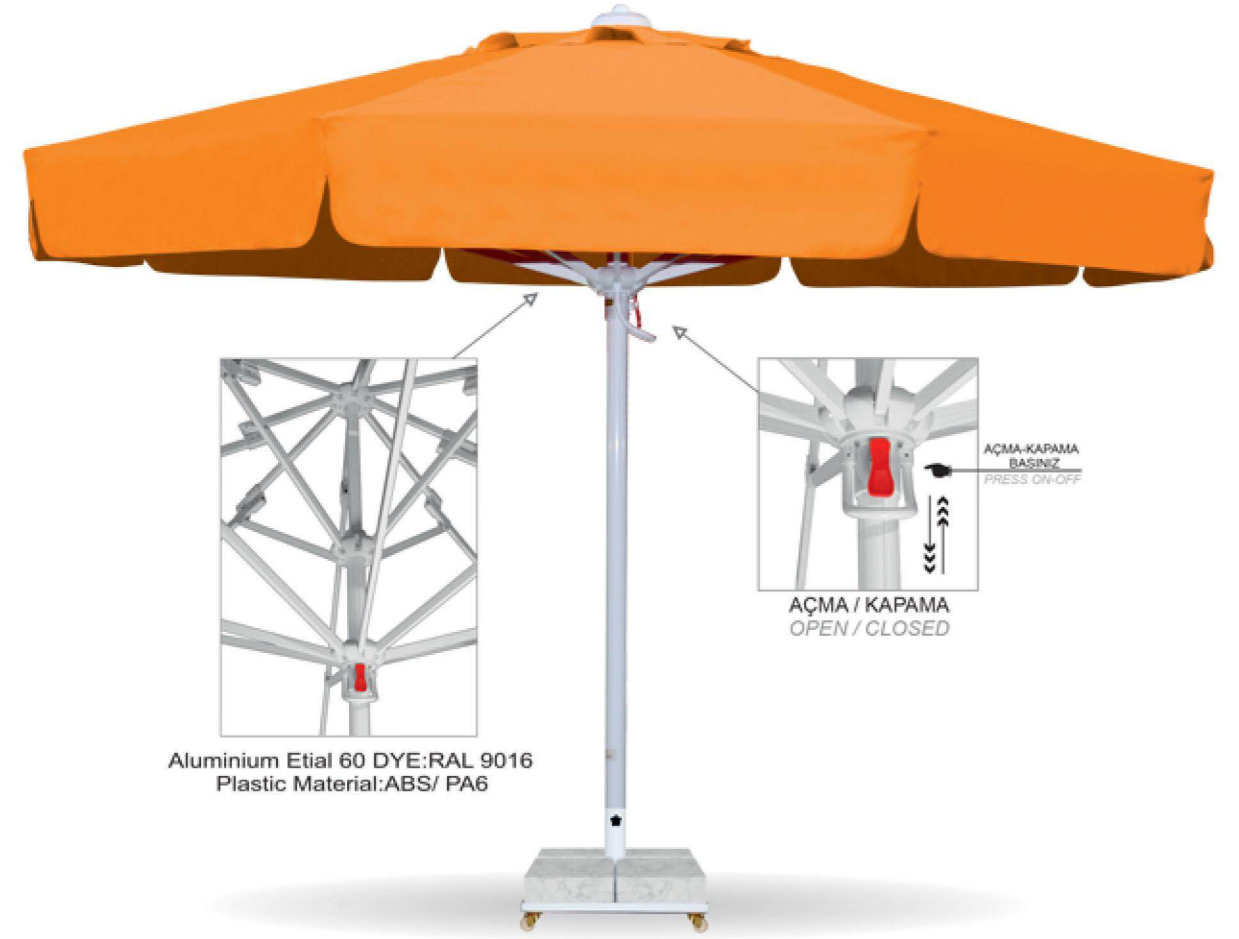

ÖLÇÜLER / SIZES

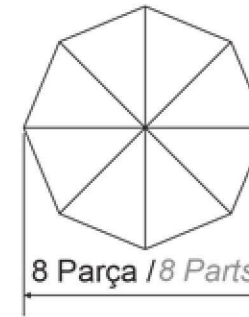

MTR 300/8....Ø300 cm.

MTR 400/8....Ø400 cm.

TEKNİK ÖZELLİKLER

TECHNICAL SPECIFICATIONS

KOD CODE	KAPLI ALAN AREA COVERED	AĞIRLIK WEIGHT	AMBALAJ PACKAGING
	m ²	Kg.	1 ad./pcs.
MTR 300/8	7	18	24x24x300 cm.
MTR 400/8	12,5	20	24x24x320 cm.

PROFİLLER / PROFILES

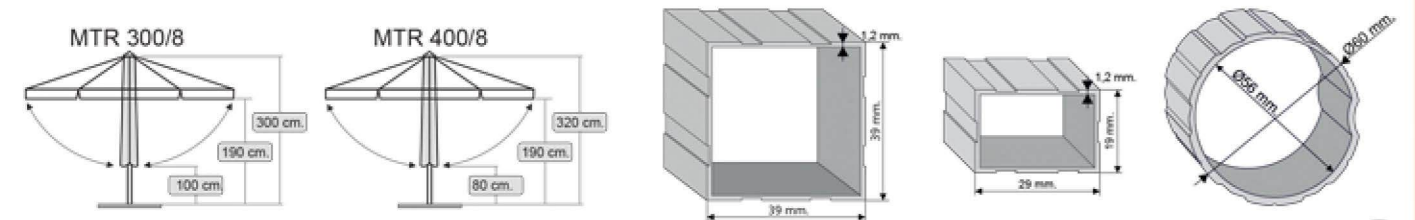

ALTLIKLAR / BASES

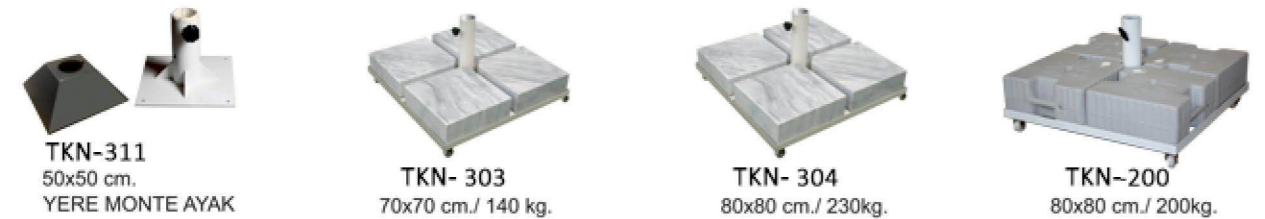

Altlıklar fiyatlara dahil değildir.
Bases are not included in the price.

MANUEL TELESKOPIK KARE

MANUEL TELESCOPIC SQUARE

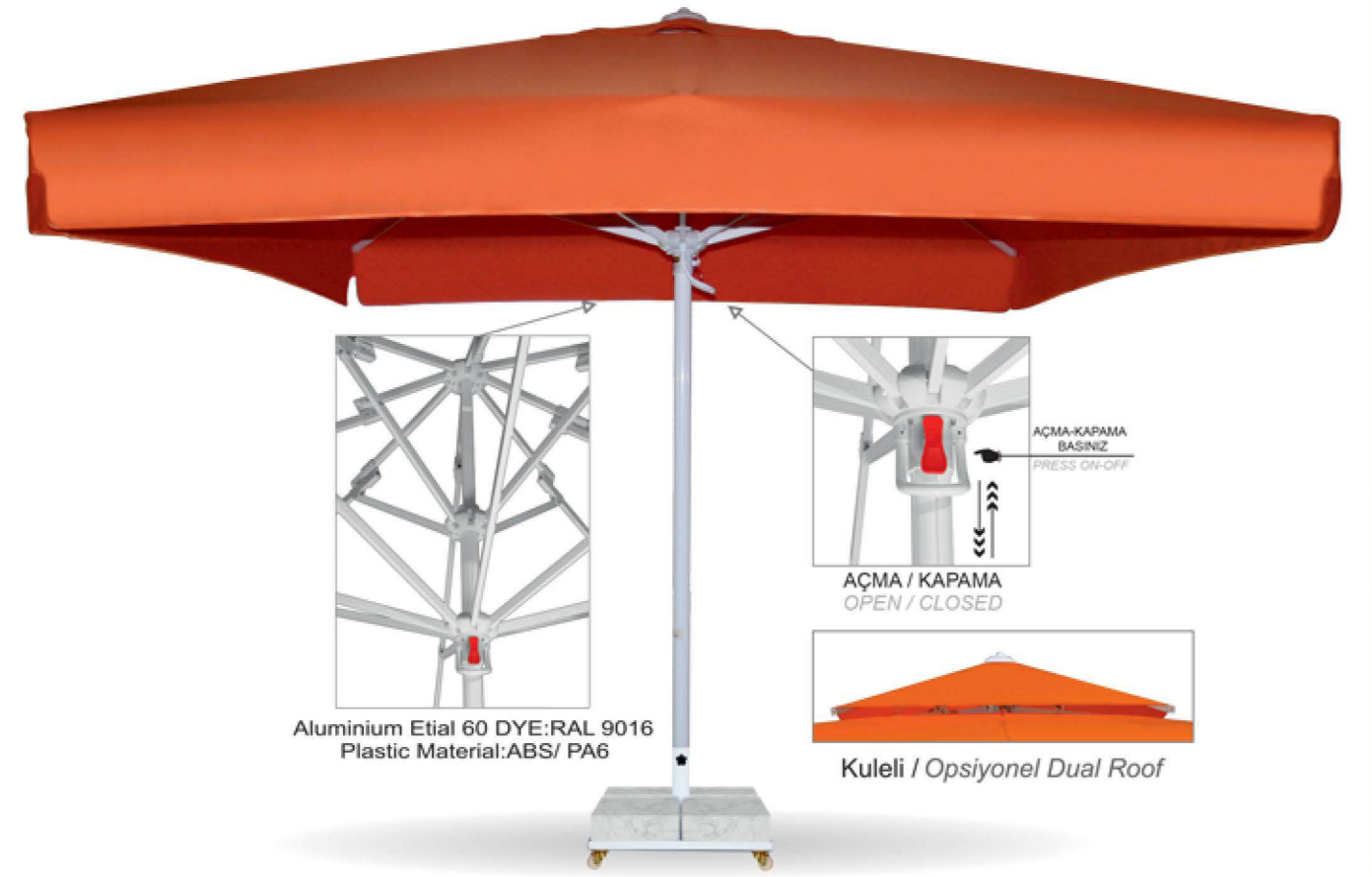

Cafe,restaurant ve havuz kenarı kullanımına uygun üretilmiştir.8 kollu,alüminyumdan üretilmiş yuvarlak şekilde şemsiyedir.

Beyaz renkli elektrostatik boya (RAL 9016) kaplamalı olarak üretilen şemsiyenin orta borusu Ø 60 mm.'dir.

İskelette kullanılan plastik parçalar,tüm dünyada şemsiye üretiminde kullanılan kırılmaya karşı 2 yıl garantili ABS ve POLYAMID Pa6 PRIME hammadde kullanılarak üretilmiştir.

Şemsiyenin rüzgar tahliyesi tepe kısmında bulunan hava kanalları ile veya tercihe göre kule sistemi olarak yapılabildiği için,rüzgarlı havalarda güvenle kullanılabilir.

Şemsiyeyi açmak için orta boru üzerinde bulunan mekanizmanın mandal kısmına bastırarak yukarı doğru hareket ettirilir,

emniyet piminin orta boruda bulunan yuvasına girmesi sağlanır.Kapatmak için mandalı bastırarak emniyet piminin yuvasından çıkması sağlanır.

Uygun altlıklar alt bölümde gösterilmiştir.Polyester-Jüt-Plastex veya Akriik kumaş seçeneği ile sizi yıllarca güneşten koruyabilir.

It is produced for cafe, restaurant and pool use. It is a square umbrella with 8 arms and made of aluminum.

The middle pipe of the umbrella, which is produced with white electrostatic paint (RAL 9016) coating, is Ø 60 mm.

Plastic parts used in the skeleton, ABS and POLYAMID with 2 years warranty against breakage used in umbrella production all over the world.

It is produced using Pa6 PRIME raw material.

Since the wind evacuation of the umbrella can be done with the air ducts on the top or as a tower system, windy can be used safely in the weather.

To open the umbrella, it is moved upwards by pressing the latch part of the mechanism on the middle pipe

It is ensured that the safety pin is inserted into its slot in the middle pipe. The safety pin is removed from its slot by pressing the latch to close.

Suitable underlays are shown in the lower section. Polyester-Jute-Plastex or Acrylic fabric options can protect you from the sun for years.

ÖLÇÜLER / SIZES

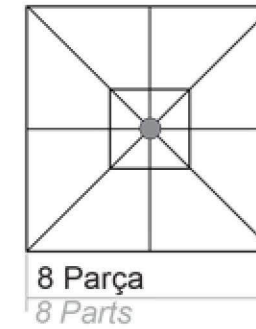

MTS 300x300/8....300x300 cm.

MTS 350x350/8....350x350 cm.

MTS 400x400/8....400x400 cm.

TEKNİK ÖZELLİKLER

TECHNICAL SPECIFICATIONS

KOD CODE	KAPLI ALAN AREA COVERED	AĞIRLIK WEIGHT	AMBALAJ PACKAGING
	m ²	Kg.	1 ad./pcs.
MTS 300x300/8	9	13	24x24x300 cm.
MTS 350x350/8	12,2	20	24x24x380 cm.
MTS 400x400/8	16	20	24x24x380 cm.

PROFİLLER / PROFILES

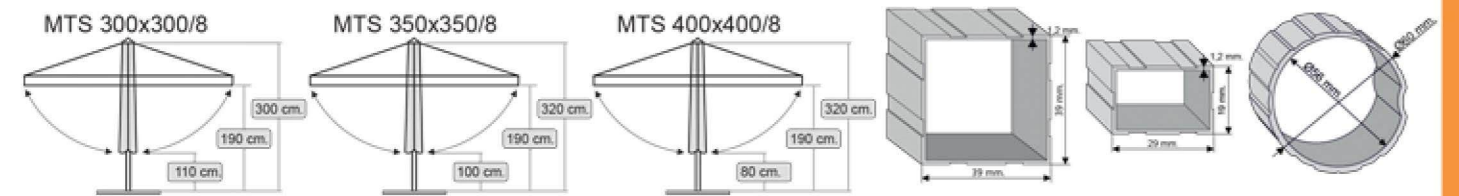

ALTLIKLAR / BASES



TKN- 311
50x50 cm.
YERE MONTE AYAK



TKN- 303
80x80 cm./ 230 kg.



TKN- 304
90x90 cm./ 260kg.



TKN- 200
80x80 cm./ 200kg.



TEKİN ŞEMSiYE
Güvenle Açılan Şemsiye
— Since 1986 —

EKO TELESKOPIK

EKO TELESKOPIK YUVARLAK

EKO TELESCOPIC ROUND



Cafe-Restaurant kullanımına uygun teleskopik sistem ile çalışan 8 kollu, alüminyumdan üretilmiş yuvarlak şekilde şemsiyedir. Beyaz veya istenilen RAL renkleri ile elektrostatik boya kaplanabilmekte, eloksallı kaplamalı olarak üretilen şemsiyenin orta borusu Ø 60 mm.'dir. İskelette bulunan plastik parçalar, tüm dünyada şemsiye üretiminde kullanılan kırılmaya karşı 2 yıl garantili ABS ve POLYAMID Pa6 PRIME hammadde kullanılarak üretilmiştir. Şemsiyenin rüzgar tahliyesi tepe kısmında bulunan hava kanalları ile veya tercihe göre kule sistemi olarak üretilmektedir. Şemsiyenin çalışması krank sistemli olup açma- kapama işlemi için çevirme kolu yardımı ile dişli sisteminin hareket ettirilmesi yeterlidir. Uygun altlıklar alt bölümde gösterilmiştir. Polyester-Jüt-Plastex veya Akriklik kumaş seçeneği ile sizi yıllarca güneşten koruyabilir.

It is an 8-arm, round umbrella made of aluminum, operating with a telescopic system suitable for cafe-restaurant use.

It can be coated with electrostatic paint with white or desired RAL colors, and the middle pipe of the umbrella, which is produced as anodized, is Ø 60 mm.

Plastic parts in the skeleton, ABS and POLYAMID with 2-year warranty against breakage, which are used in umbrella production all over the world.

It is produced using Pa6 PRIME raw material.

The wind evacuation of the umbrella is produced with air ducts on the top or as a tower system according to preference.

The operation of the umbrella is with a crank system and it is sufficient to move the gear system with the help of the turning handle for opening and closing operation.

Suitable bases are shown in the lower section. Polyester-Jute-Plastex or Acrylic fabric options can protect you from the sun for years.



ÖLÇÜLER / SIZES

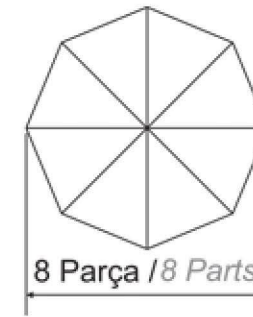

ETR 300/8....Ø300 cm.
ETR 400/8....Ø400 cm.
ETR 500/8....Ø500 cm.

TEKNİK ÖZELLİKLER TECHNICAL SPECIFICATIONS

KOD CODE	KAPLI ALAN AREA COVERED	AĞIRLIK WEIGHT	AMBALAJ PACKAGING
	m ²	Kg.	1 ad./pcs.
ETR 300/8	7	25	26x26x370 cm.
ETR 400/8	12,5	28	26x26x410 cm.
ETR 400/8	19,6	30	26x26x435 cm.

PROFİLLER / PROFILES

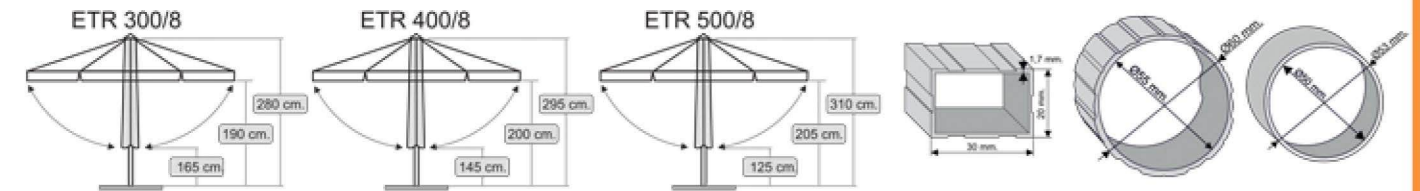

ALTLIKLAR / BASES

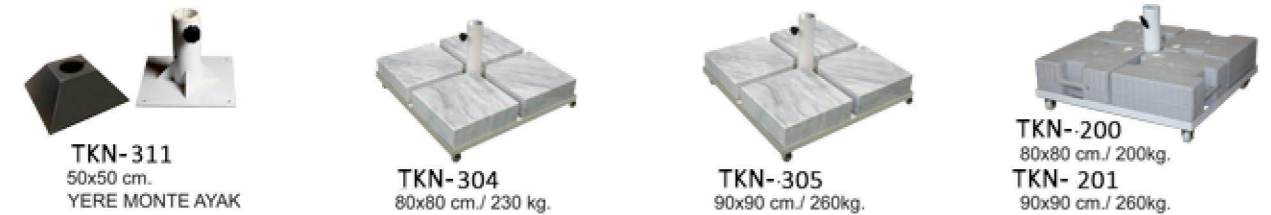

TKN-311
50x50 cm.
YERE MONTE AYAK

TKN-304
80x80 cm / 230 kg.

TKN-305
90x90 cm / 260kg.

TKN-200
80x80 cm / 200kg.
TKN-201
90x90 cm / 260kg.

Altlıklar fiyatlara dahil değildir.
Bases are not included in the price.

EKO TELESKOPIK KARE

EKO TELESCOPIC SQUARE



Cafe-Restaurant kullanımına uygun teleskopik sistem ile çalışan 8 kollu, alüminyumdan üretilmiş kare şekilde şemsiyedir.

Beyaz veya istenilen RAL renkleri ile elektrostatik boya kaplanabilmekte, eloksallı kaplamalı olarak üretilen şemsiyenin orta borusu Ø 60 mm.'dir.

İskelette bulunan plastik parçalar, tüm dünyada şemsiye üretiminde kullanılan kırılmaya karşı 2 yıl garantili ABS ve POLYAMID

Pa6 PRIME hammadde kullanılarak üretilmiştir.

Şemsiyenin rüzgar tahliyesi tepe kısmında bulunan hava kanalları ile veya tercihe göre kule sistemi olarak üretilmektedir.

Şemsiyenin çalışması krank sistemli olup açma- kapama işlemi için çevirme kolu yardımı ile dişli sisteminin hareket ettirilmesi yeterlidir.

Uygun altlıklar alt bölümde gösterilmiştir. Polyester-Jüt-Plastex veya Akriklik kumaş seçeneği ile sizi yıllarca güneşten koruyabilir.

It is an 8-arm, square umbrella made of aluminum, operating with a telescopic system suitable for cafe-restaurant use.

It can be coated with electrostatic paint with white or desired RAL colors, and the middle pipe of the umbrella, which is produced as anodized, is Ø 60 mm.

Plastic parts in the skeleton, ABS and POLYAMID with 2-year warranty against breakage, which are used in umbrella production all over the world.

It is produced using Pa6 PRIME raw material.

The wind evacuation of the umbrella is produced with air ducts on the top or as a tower system according to preference.

The operation of the umbrella is with a crank system and it is sufficient to move the gear system with the help of the turning handle for opening and closing operation.

Suitable bases are shown in the lower section. Polyester-Jute-Plastex or Acrylic fabric options can protect you from the sun for years.

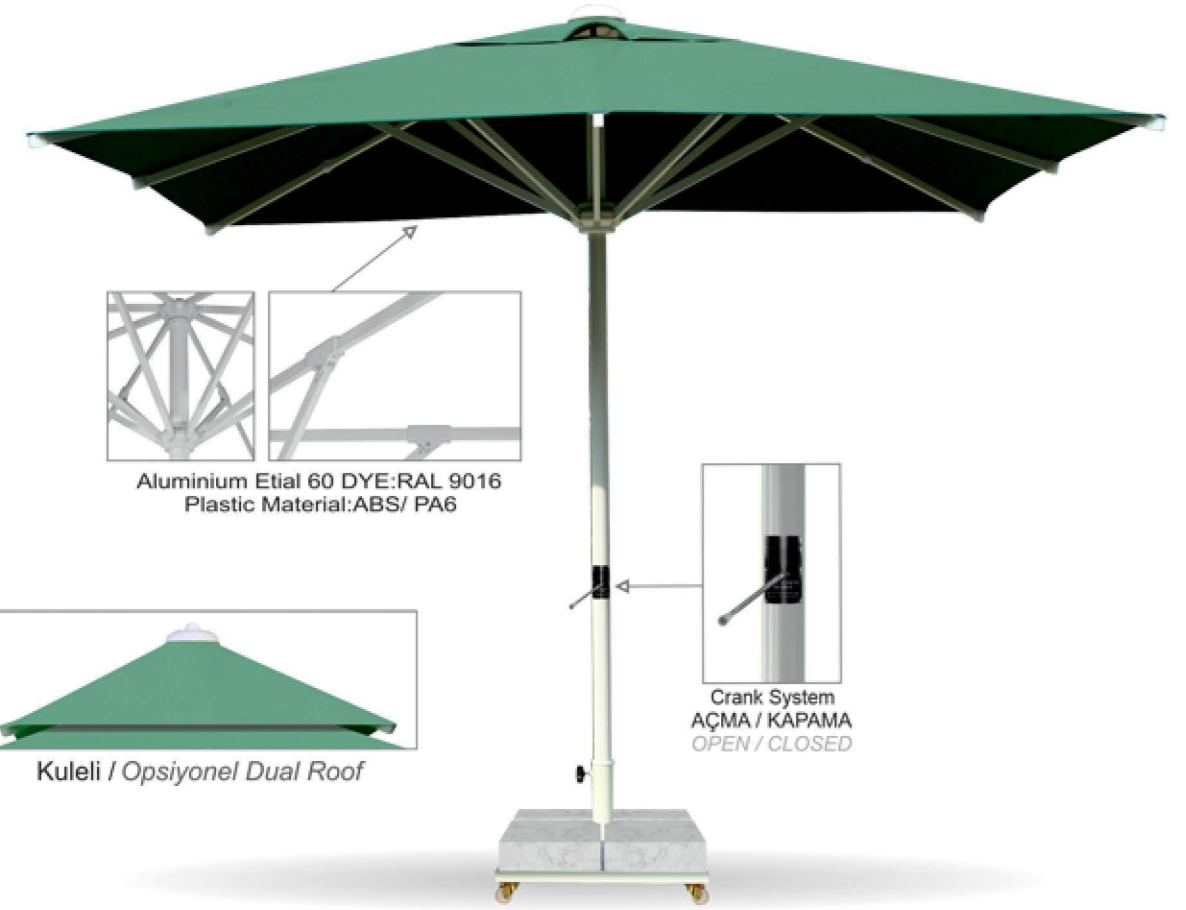

ÖLÇÜLER / SIZES

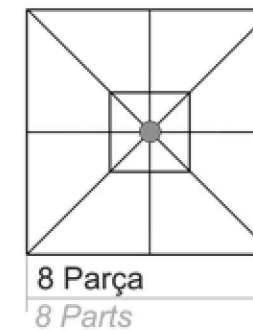

ETS 300x300/8....300x300 cm.

ETS 350x350/8....350x350 cm.

ETS 300x400/8....300x400 cm.

ETS 400x400/8....400x400 cm.

TEKNİK ÖZELLİKLER

TECHNICAL SPECIFICATIONS

KOD CODE	KAPLI ALAN AREA COVERED	AĞIRLIK WEIGHT	AMBALAJ PACKAGING
	m ²	Kg.	1 ad./pcs.
ETS 300x300/8	9	30	26x26x370 cm.
ETS 350x350/8	12,2	31	26x26x415 cm.
ETS 300x400/8	12	32	26x26x420 cm.
ETS 400x400/8	16	33	26x26x435 cm.

PROFİLLER / PROFILES

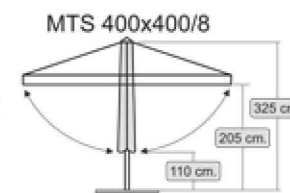
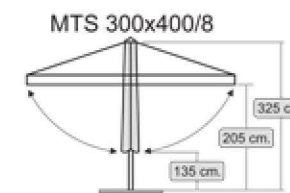
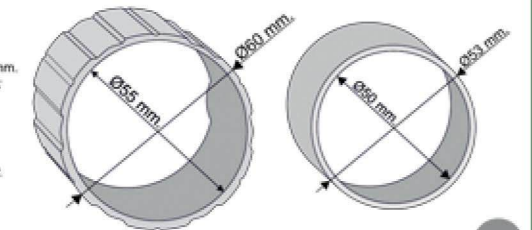
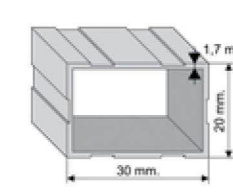
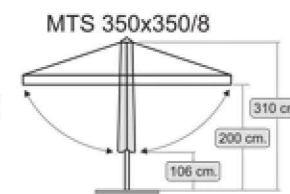
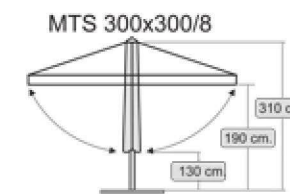

ALTLIKLAR / BASES



TKN-311
50x50 cm.
YERE MONTE AYAK



TKN-304
80x80 cm / 230 kg.
TKN-305
90x90 cm / 260kg.



TKN-200
80x80 cm / 200kg.
TKN-201
90x90 cm / 260kg.



TEKİN ŞEMSIYE®
Güvenle Açılan Şemsiye
— Since 1986 —

MY SUNLIFE

MY SUNLIFE YUVARLAK

MY SUNLIFE ROUND



Cafe-Restaurant kullanımına uygun teleskopik sistem ile çalışan 8 kollu, alüminyumdan üretilmiş yuvarlak şekilde şemsiyedir.

Beyaz veya istenilen RAL renkleri ile elektrostatik boya kaplanabilmekte, eloksallı kaplamalı olarak üretilen şemsiyenin orta borusu Ø 84 mm.'dir.

İskelette bulunan plastik parçalar, tüm dünyada şemsiye üretiminde kullanılan kırılmaya karşı 2 yıl garantili ABS ve POLYAMID

Pa6 PRIME hammadde kullanılarak üretilmiştir.

Şemsiyenin rüzgar tahliyesi tepe kısmında bulunan hava kanalları ile veya tercihe göre kule sistemi olarak üretilmektedir.

Şemsiyenin çalışması krank sistemli olup açma- kapama işlemi için çevirme kolu yardımı ile dişli sisteminin hareket ettirmesi yeterlidir.

Uygun altlıklar alt bölümde gösterilmiştir. Polyester-Jüt-Plastex veya Akrilik kumaş seçeneği ile sizi yıllarca güneşten koruyabilir.

It is an 8-arm, round umbrella made of aluminum, operating with a telescopic system suitable for cafe-restaurant use.

It can be coated with electrostatic paint with white or desired RAL colors, and the middle pipe of the umbrella, which is produced as anodized, is Ø 84 mm.

Plastic parts in the skeleton, ABS and POLYAMID with 2-year warranty against breakage, which are used in umbrella production all over the world.

It is produced using Pa6 PRIME raw material.

The wind evacuation of the umbrella is produced with air ducts on the top or as a tower system according to preference.

The operation of the umbrella is with a crank system and it is sufficient to move the gear system with the help of the turning handle for opening and closing operation.

Suitable bases are shown in the lower section. Polyester-Jute-Plastex or Acrylic fabric options can protect you from the sun for years.



ÖLÇÜLER / SIZES

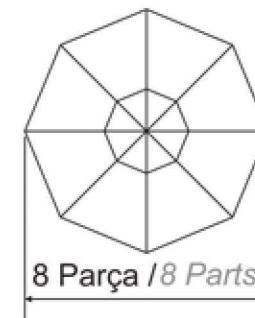

UTR 400/8...Ø400 cm.
UTR 500/8...Ø500 cm.
UTR 600/8...Ø600 cm.

TEKNİK ÖZELLİKLER

TECHNICAL SPECIFICATIONS

KOD CODE	KAPLI ALAN AREA COVERED	AĞIRLIK WEIGHT	AMBALAJ PACKAGING
	m ²	Kg.	1 ad./pcs.
UTR 400/8	12,5	25	26x26x380 cm.
UTR 500/8	19,6	35	26x26x410 cm.
UTR 600/8	28	60	26x26x435 cm.

PROFİLLER / PROFILES

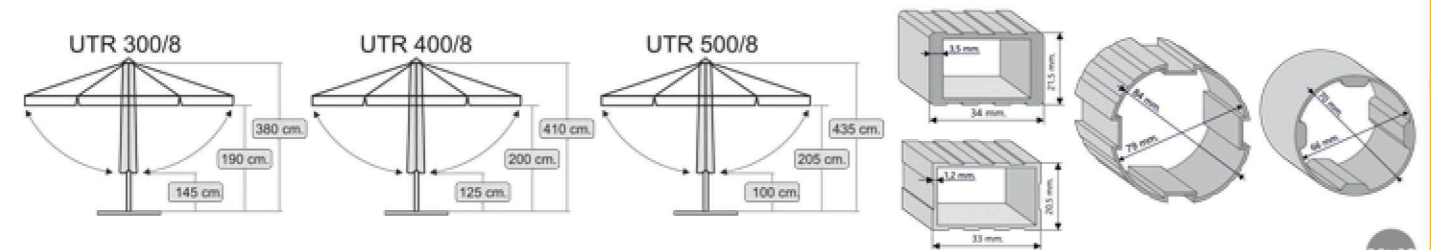

ALTLIKLAR / BASES

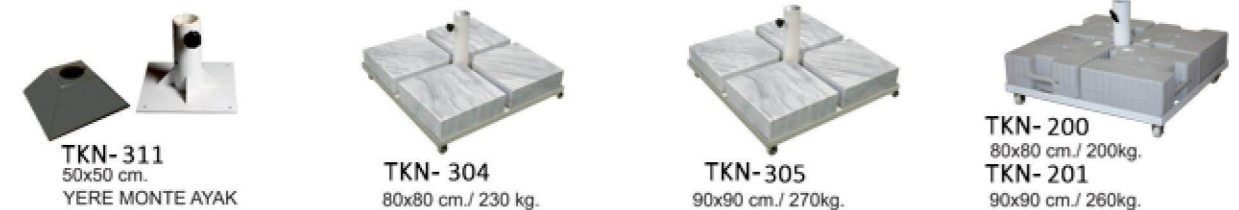

TKN- 311
50x50 cm.
YERE MONTE AYAK

TKN- 304
80x80 cm./ 230 kg.

TKN- 305
90x90 cm./ 270kg.

TKN- 200
80x80 cm./ 200kg.
TKN- 201
90x90 cm./ 260kg.

Altlıklar fiyatlara dahil değildir.
Bases are not included in the price.

MY SUNLIFE KARE MY SUNLIFE SQUARE



Cafe-Restaurant kullanımına uygun teleskopik sistem ile çalışan 8 kollu, alüminyumdan üretilmiş kare şekilde şemsiyedir.

Beyaz veya istenilen RAL renkleri ile elektrostatik boya kaplanabilmekte, eloksallı kaplamalı olarak üretilen şemsiyenin orta borusu Ø 84 mm.'dir.

İskelette bulunan plastik parçalar, tüm dünyada şemsiye üretiminde kullanılan kırılmaya karşı 2 yıl garantili ABS ve POLYAMID Pa6 PRIME hammadde kullanılarak üretilmiştir.

Şemsiyenin rüzgar tahliyesi tepe kısmında bulunan hava kanalları ile veya tercihe göre kule sistemi olarak üretilmektedir.

Şemsiyenin çalışması krank sistemli olup açma- kapama işlemi için çevirme kolu yardımı ile dişli sisteminin hareket ettirilmesi yeterlidir.

Uygun altlıklar alt bölümde gösterilmiştir. Polyester-Jüt-Plastex veya Akrilik kumaş seçeneği ile sizi yıllarca güneşten koruyabilir.

It is an 8-arm, square umbrella made of aluminum, operating with a telescopic system suitable for cafe-restaurant use.

It can be coated with electrostatic paint with white or desired RAL colors, and the middle pipe of the umbrella, which is produced as anodized, is Ø 84 mm.

Plastic parts in the skeleton, ABS and POLYAMID with 2-year warranty against breakage, which are used in umbrella production all over the world.

It is produced using Pa6 PRIME raw material.

The wind evacuation of the umbrella is produced with air ducts on the top or as a tower system according to preference.

The operation of the umbrella is with a crank system and it is sufficient to move the gear system with the help of the turning handle for opening and closing operation.

Suitable bases are shown in the lower section. Polyester-Jute-Plastex or Acrylic fabric options can protect you from the sun for years.



Aluminium Etial 60 DYE:RAL 9016
Plastic Material:ABS/ PA6

Kuleli / Opsiyonel Dual Roof

Crank System
AÇMA / KAPAMA
OPEN / CLOSED

ÖLÇÜLER / SIZES

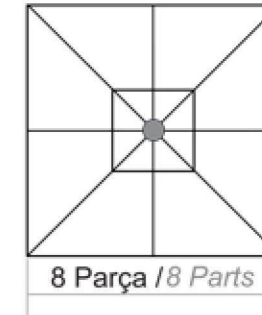

UTS 300x300/8....300x300 cm.
UTS 350x350/8....350x350 cm.
UTS 300x400/8....300x400 cm.
UTS 400x400/8....400x400 cm.
UTS 450x450/8....450x450 cm.
UTS 500x500/8....500x500 cm.

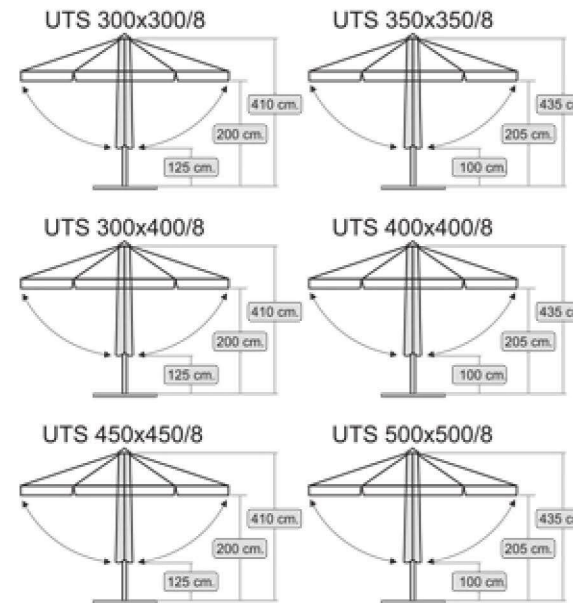

TEKNİK ÖZELLİKLER TECHNICAL SPECIFICATIONS

KOD CODE	KAPLI ALAN AREA COVERED	AĞIRLIK WEIGHT	AMBALAJ PACKAGING
	m ²	Kg.	1 ad./pcs.
UTS 300x300/8	9	25	40x40x395 cm.
UTS 350x350/8	12,2	28	40x40x420 cm.
UTS 300x400/8	12	30	40x40x440 cm.
UTS 400x400/8	16	33	40x40x440 cm.
UTS 450x450/8	20,2	64	40x40x420 cm.
UTS 500x500/8	25	65	40x40x515 cm.

PROFİLLER / PROFILES

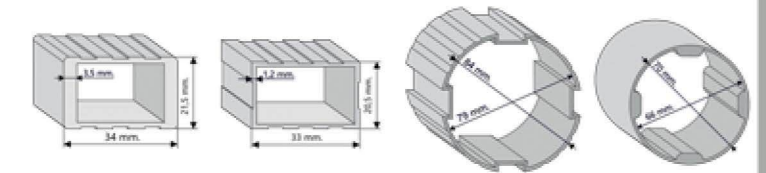

ALTLIKLAR / BASES



TKN-311
50x50 cm.
YERE MONTE AYAK

TKN-304
80x80 cm./ 230 kg.
TKN-305
90x90 cm./ 270kg.

TKN-200
80x80 cm./ 200kg.
TKN-201
90x90 cm./ 260kg.

Altlıklar fiyatlara dahil değildir.
Bases are not included in the price.



MY SUNLIFE EXCLUSIVE

MY SUNLIFE EXCLUSIVE YUVARLAK

MY SUNLIFE EXCLUSIVE ROUND

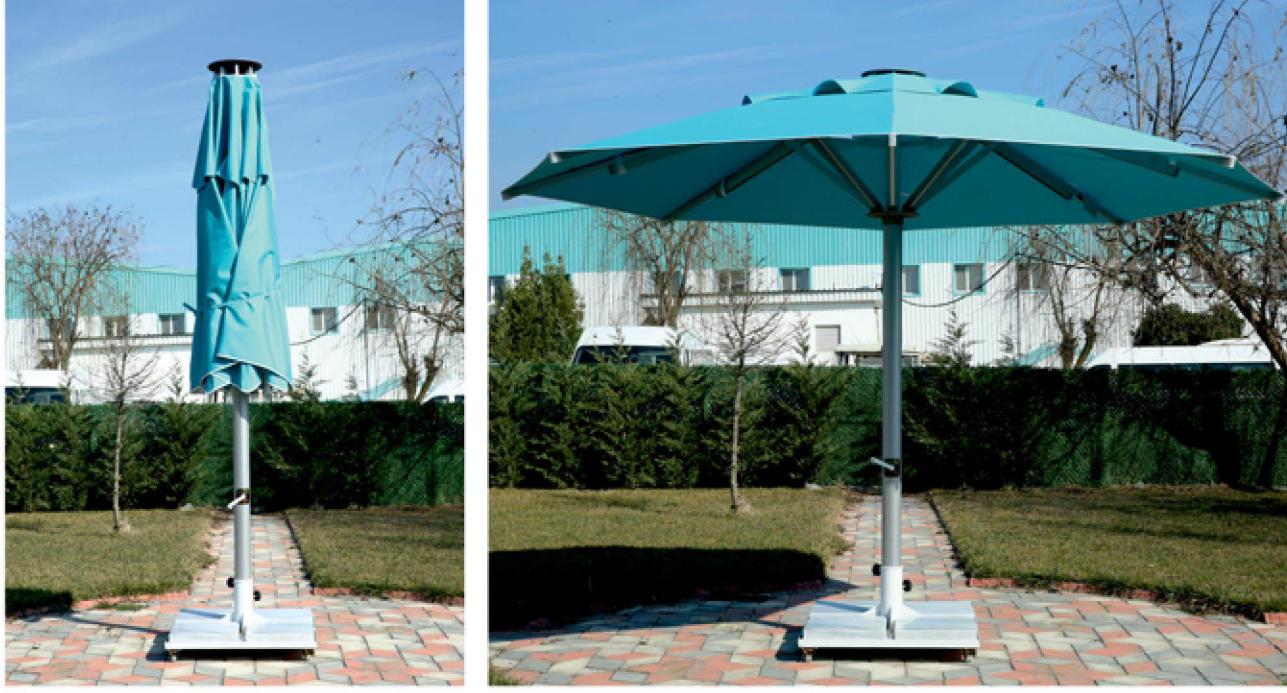

Cafe-Restaurant kullanımına uygun teleskopik sistem ile çalışan 8 kollu, alüminyumdan üretilmiş yuvarlak şekilde şemsiyedir.

Beyaz veya istenilen RAL renkleri ile elektrostatik boya kaplanabilmekte, eloksallı kaplamalı olarak üretilen şemsiyenin orta borusu Ø 100 mm.'dir.

İskelette bulunan plastik parçalar, tüm dünyada şemsiye üretiminde kullanılan kırılmaya karşı 2 yıl garantili ABS ve POLYAMID

Pa6 PRIME hammadde kullanılarak üretilmiştir.

Şemsiyenin rüzgar tahliyesi tepe kısmında bulunan hava kanalları ile veya tercihe göre kule sistemi olarak üretilmektedir.

Şemsiyenin çalışması krank sistemli olup açma- kapama işlemi için çevirme kolu yardımı ile dişli sisteminin hareket ettirilmesi yeterlidir.

Uygun altlıklar alt bölümde gösterilmiştir. Polyester veya Akriklik kumaş seçeneği ile sizi yıllarca güneşten koruyabilir.

It is an 8-arm, round umbrella made of aluminum, operating with a telescopic system suitable for cafe-restaurant use.

It can be coated with electrostatic paint with white or desired RAL colors, and the middle pipe of the umbrella, which is produced as anodized, is Ø 100 mm.

Plastic parts in the skeleton, ABS and POLYAMID with 2-year warranty against breakage, which are used in umbrella production all over the world.

It is produced using Pa6 PRIME raw material.

The wind evacuation of the umbrella is produced with air ducts on the top or as a tower system according to preference.

The operation of the umbrella is with a crank system and it is sufficient to move the gear system with the help of the turning handle for opening and closing operation.

Suitable bases are shown in the lower section. Polyester or Acrylic fabric options can protect you from the sun for years.



ÖLÇÜLER / SIZES

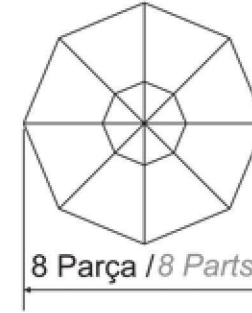

SDR 500/8....Ø400 cm.
SDR 600/8....Ø500 cm.
SDR 700/8....Ø600 cm.

TEKNİK ÖZELLİKLER TECHNICAL SPECIFICATIONS

KOD CODE	KAPLI ALAN AREA COVERED	AĞIRLIK WEIGHT	AMBALAJ PACKAGING
	m ²	Kg.	1 ad./pcs.
SDR 500/8	20	64	40x40x420 cm.
SDR 600/8	28	77	40x40x450 cm.
SDR 700/8	38,5	86	40x40x468 cm.

PROFİLLER / PROFILES

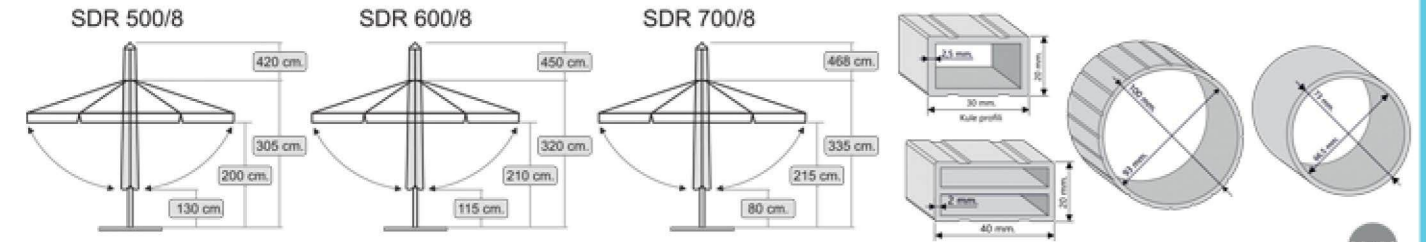

ALTILIKLAR / BASES

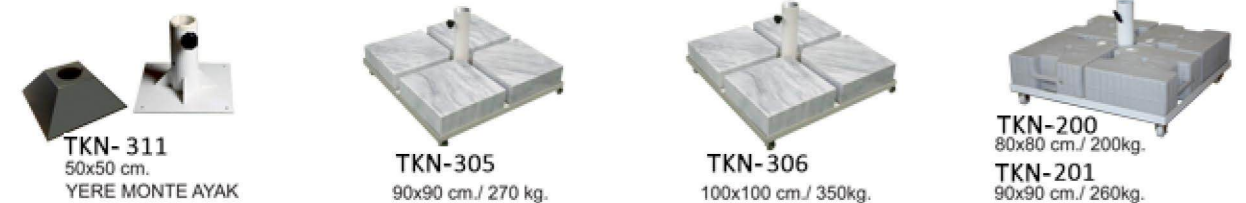

Altlıklar fiyatlara dahil değildir.
Bases are not included in the price.

MY SUNLIFE EXCLUSIVE KARE

MY SUNLIFE EXCLUSIVE SQUARE



Cafe-Restaurant kullanımına uygun teleskopik sistem ile çalışan 8 kollu, alüminyumdan üretilmiş kare şekilde şemsiyedir.

Beyaz veya istenilen RAL renkleri ile elektrostatik boya kaplanabilmekte, eloksal kaplamalı olarak üretilen şemsiyenin orta borusu Ø 100 mm.'dir.

İskelette bulunan plastik parçalar, tüm dünyada şemsiye üretiminde kullanılan kırılmaya karşı 2 yıl garantili ABS ve POLYAMID

Pa6 PRIME hammadde kullanılarak üretilmiştir.

Şemsiyenin rüzgar tahliyesi tepe kısmında bulunan hava kanalları ile veya tercihe göre kule sistemi olarak üretilmektedir.

Şemsiyenin çalışması krank sistemli olup açma- kapama işlemi için çevirme kolu yardımı ile dişli sisteminin hareket ettirilmesi yeterlidir.

Uygun altlıklar alt bölümde gösterilmiştir. Polyester veya Akriklik kumaş seçeneği ile sizi yıllarca güneşten koruyabilir.

It is an 8-arm, square umbrella made of aluminum, operating with a telescopic system suitable for cafe-restaurant use.

It can be coated with electrostatic paint with white or desired RAL colors, and the middle pipe of the umbrella, which is produced as anodized, is Ø 100 mm.

Plastic parts in the skeleton, ABS and POLYAMID with 2-year warranty against breakage, which are used in umbrella production all over the world.

It is produced using Pa6 PRIME raw material.

The wind evacuation of the umbrella is produced with air ducts on the top or as a tower system according to preference.

The operation of the umbrella is with a crank system and it is sufficient to move the gear system with the help of the turning handle for opening and closing operation.

Suitable bases are shown in the lower section. Polyester or Acrylic fabric options can protect you from the sun for years.

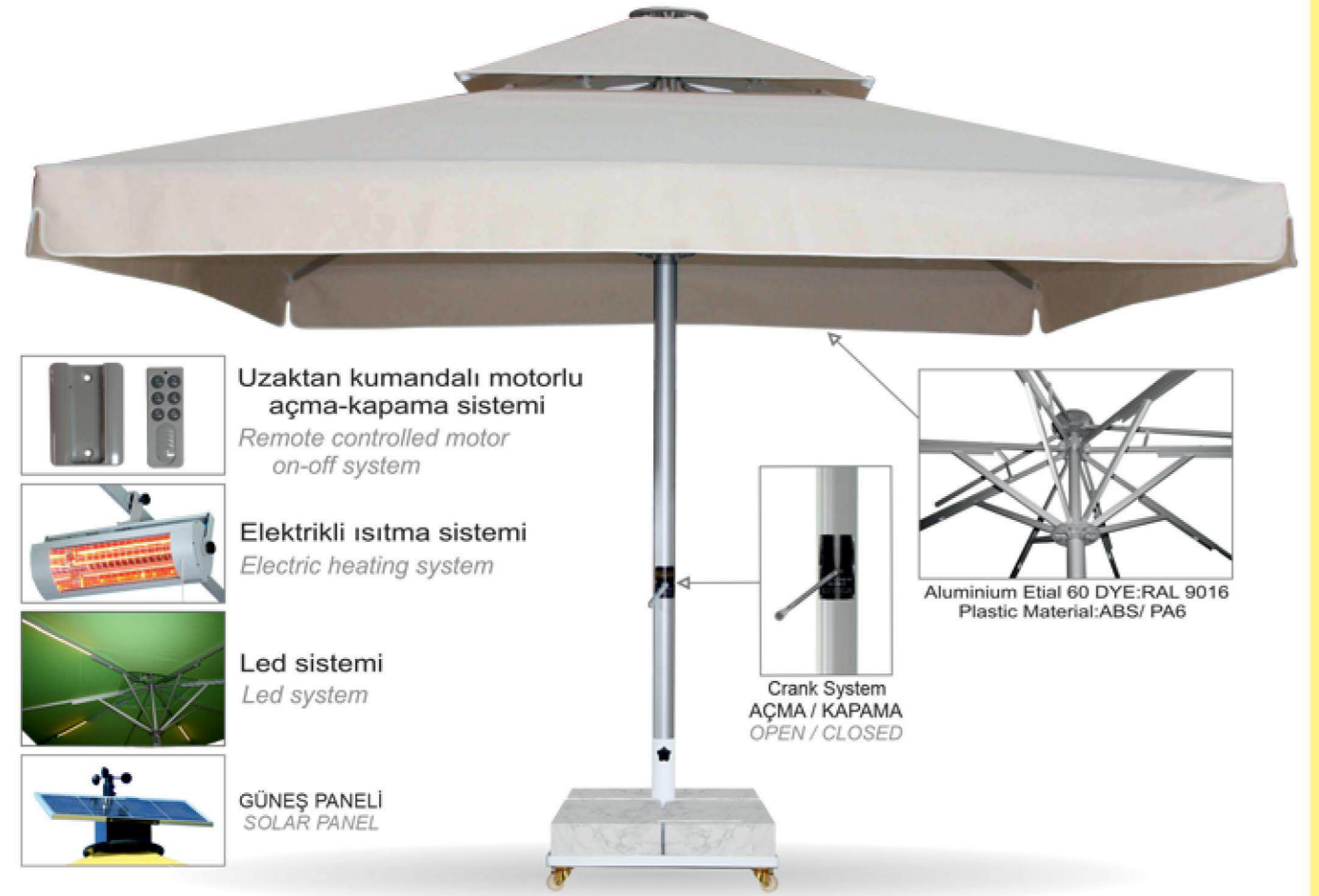

ÖLÇÜLER / SIZES

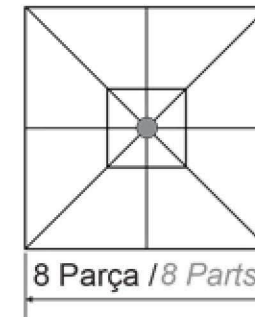

SDS 300x300/8....300x300 cm.
SDS 350x350/8....350x350 cm.
SDS 400x400/8....400x400 cm.
SDS 450x450/8....450x450 cm.
SDS 500x500/8....500x500 cm.
SDS 600x600/8....600x600 cm.

TEKNİK ÖZELLİKLER

TECHNICAL SPECIFICATIONS

KOD CODE	KAPLI ALAN AREA COVERED	AĞIRLIK WEIGHT	AMBALAJ PACKAGING
	m ²	Kg.	1 ad./pcs.
SDS 300x300/8	9	60	40x40x425cm.
SDS 350x350/8	12,2	68	40x40x425cm.
SDS 400x400/8	16	76	40x40x435cm.
SDS 450x450/8	20,2	84	40x40x450cm.
SDS 500x500/8	25	91	40x40x490cm.
SDS 600x600/8	36	93	40x40x505cm.

PROFİLLER / PROFILES

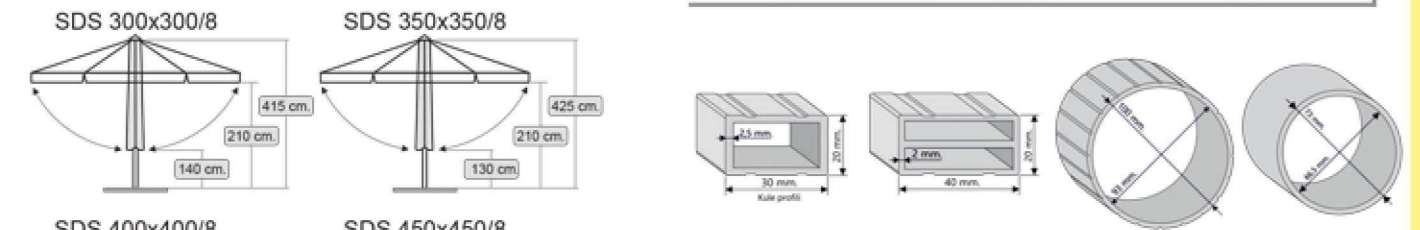

ALTIKLAR / BASES



Altılıklar fiyatlara dahil değildir.
Bases are not included in the price.



TEKİN ŞEMSIYE®
Güvenle Açılan Şemsiye
— Since 1986 —

LOTUS

LOTUS YUVARLAK LOTUS ROUND



Cafe-Restaurant kullanımına uygun teleskopik sistem ile çalışan 8 kollu, alüminyumdan üretilmiş yuvarlak şekilde şemsiyedir.

Beyaz veya istenilen RAL renkleri ile elektrostatik boya kaplanabilmekte, eloksallı kaplamalı olarak üretilen şemsiyenin orta borusu Ø 84 mm.'dir.

İskelette bulunan plastik parçalar, tüm dünyada şemsiye üretiminde kullanılan kırılmaya karşı 2 yıl garantili ABS ve POLYAMID

Pa6 PRIME hammadde kullanılarak üretilmiştir.

Şemsiyenin çalışması krank sistemli olup açma- kapama işlemi için çevirme kolu yardımı ile dişli sisteminin hareket ettirilmesi yeterlidir.

It is an 8-arm, round umbrella made of aluminum, operating with a telescopic system suitable for cafe-restaurant use.

It can be coated with electrostatic paint with white or desired RAL colors, and the middle pipe of the umbrella, which is produced as anodized, is Ø 84 mm.

Plastic parts in the skeleton, ABS and POLYAMID with 2-year warranty against breakage, which are used in umbrella production all over the world.

It is produced using Pa6 PRIME raw material.

The operation of the umbrella is with a crank system and it is sufficient to move the gear system with the help of the turning handle for opening and closing operation.

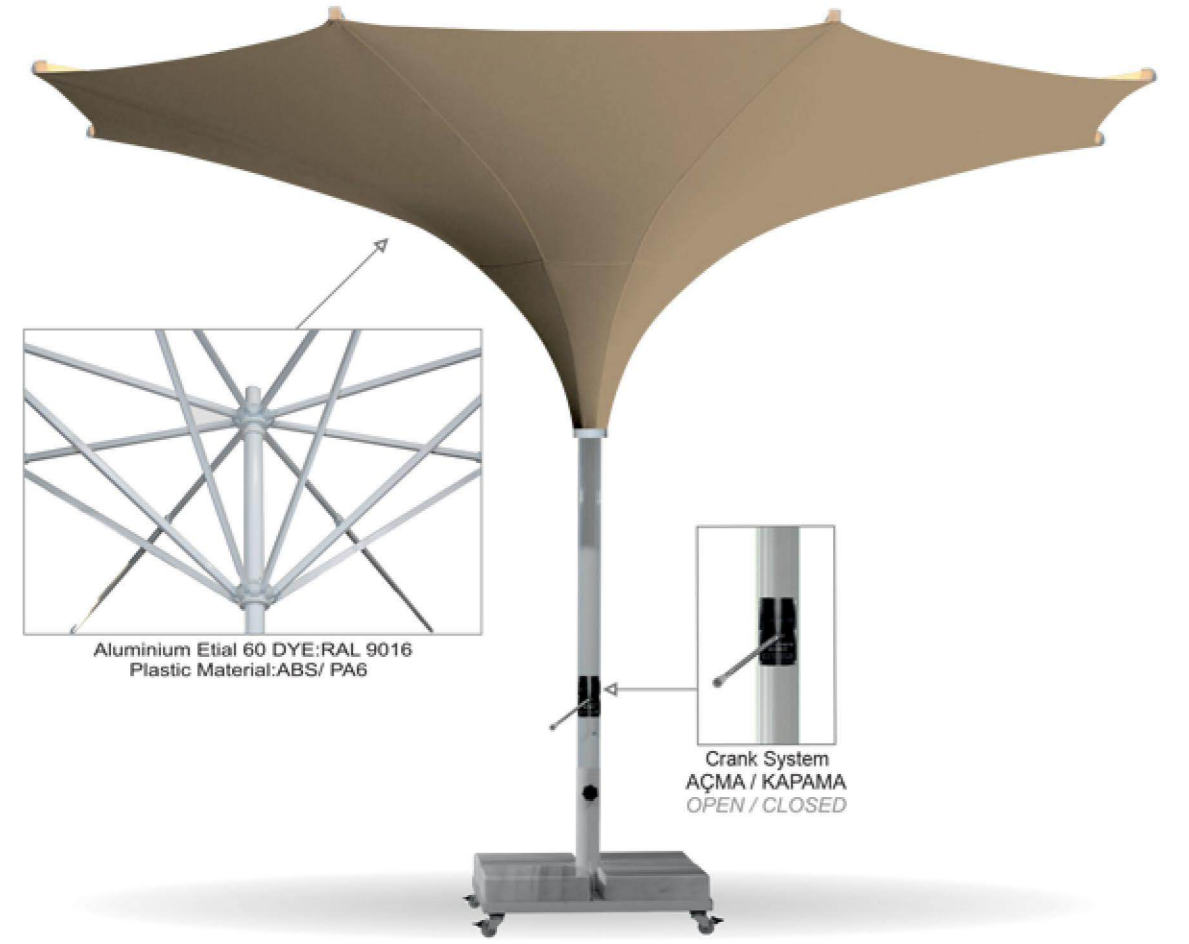

ÖLÇÜLER / SIZES

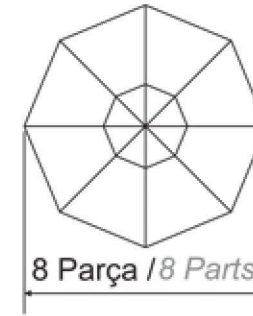

Tulibella R 400/8....Ø400 cm.
Tulibella R 500/8....Ø500 cm.
Tulibella R 600/8....Ø600 cm.

TEKNİK ÖZELLİKLER TECHNICAL SPECIFICATIONS

KOD CODE	KAPLI ALAN AREA COVERED	AĞIRLIK WEIGHT	AMBALAJ PACKAGING
	m ²	Kg.	1 ad./pcs.
Tulibella R 400/8	12,5	37	26x26x400 cm.
Tulibella R 500/8	20	45	26x26x450 cm.
Tulibella R 600/8	28	60	26x26x495 cm.

PROFİLLER / PROFILES

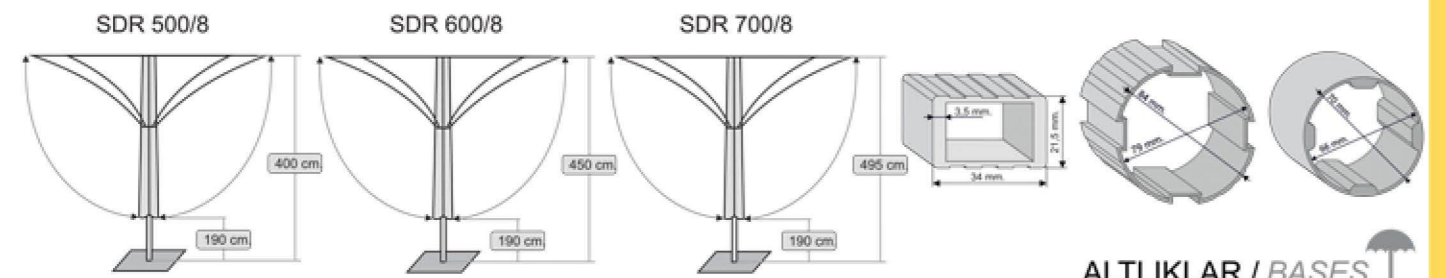

ALTIKLAR / BASES



Altıklar fiyatlara dahil değildir.
Bases are not included in the price.

LOTUS KARE LOTUS SQUARE

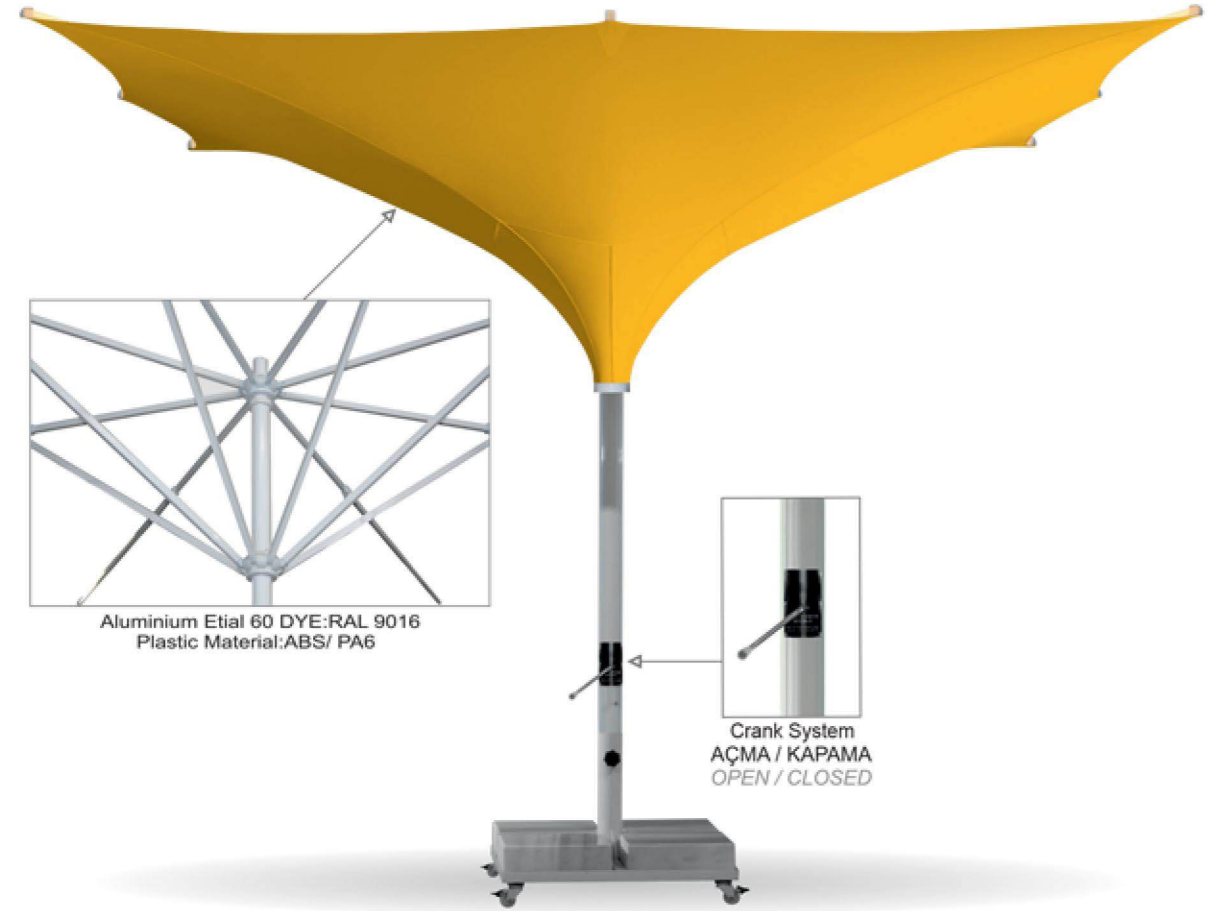

Cafe-Restaurant kullanımına uygun teleskopik sistem ile çalışan 8 kollu,alüminyumdan üretilmiş kare şekilde şemsiyedir.
Beyaz veya istenilen RAL renkleri ile elektrostatik boya kaplanabilmekte,eloksal kaplamalı olarak üretilen şemsiyenin orta borusu Ø 84 mm.'dir.
İskelette bulunan plastik parçalar,tüm dünyada şemsiye üretiminde kullanılan kırılmaya karşı 2 yıl garantili ABS ve POLYAMID
Pa6 PRIME hammadde kullanılarak üretilmiştir.
Şemsiyenin çalışması krank sistemli olup açma- kapama işlemi için çevirme kolu yardımı ile dişli sisteminin hareket ettirilmesi yeterlidir.

It is an 8-arm, square umbrella made of aluminum, operating with a telescopic system suitable for cafe-restaurant use.

It can be coated with electrostatic paint with white or desired RAL colors, and the middle pipe of the umbrella, which is produced as anodized, is Ø 84 mm.

Plastic parts in the skeleton, ABS and POLYAMID with 2-year warranty against breakage, which are used in umbrella production all over the world.

It is produced using Pa6 PRIME raw material.

The operation of the umbrella is with a crank system and it is sufficient to move the gear system with the help of the turning handle for opening and closing operation.

ÖLÇÜLER / SIZES

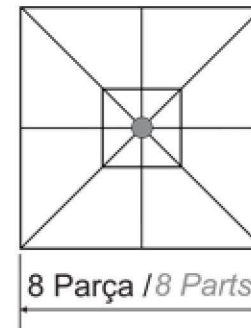

Tulibella S 400x400/8....400x400 cm.
Tulibella S 500x500/8....500x500 cm.

TEKNİK ÖZELLİKLER TECHNICAL SPECIFICATIONS

KOD CODE	KAPLI ALAN AREA COVERED	AĞIRLIK WEIGHT	AMBALAJ PACKAGING
	m ²	Kg.	1 ad./pcs.
Tulibella S 400x400/8	16	48	26x26x420 cm.
Tulibella S 500x500/8	25	65	26x26x500 cm.

PROFİLLER / PROFILES

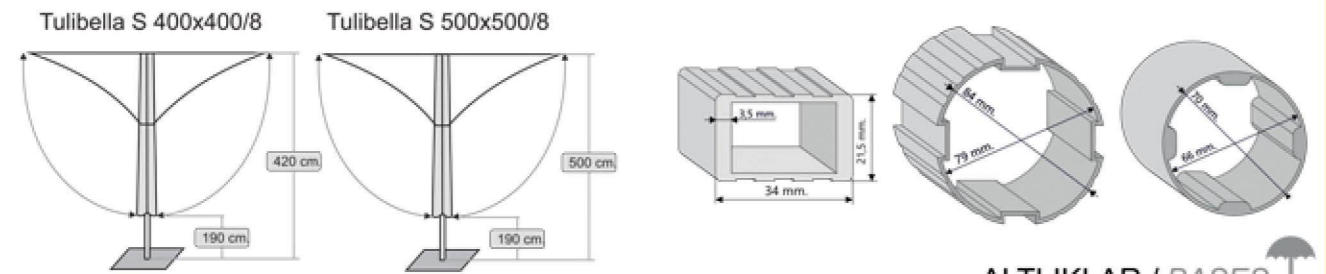

ALTIKLAR / BASES



TKN-311
50x50 cm.
YERE MONTE AYAK



TKN-304
80x80 cm./ 230kg.



TKN-305
90x90 cm./ 270 kg.



TKN-200
80x80 cm./ 200kg.
TKN-201
90x90 cm./ 260kg.

Altıklar fiyatlara dahil değildir.
Bases are not included in the price.

TROM POLE YUVARLAK TROM POLE ROUND

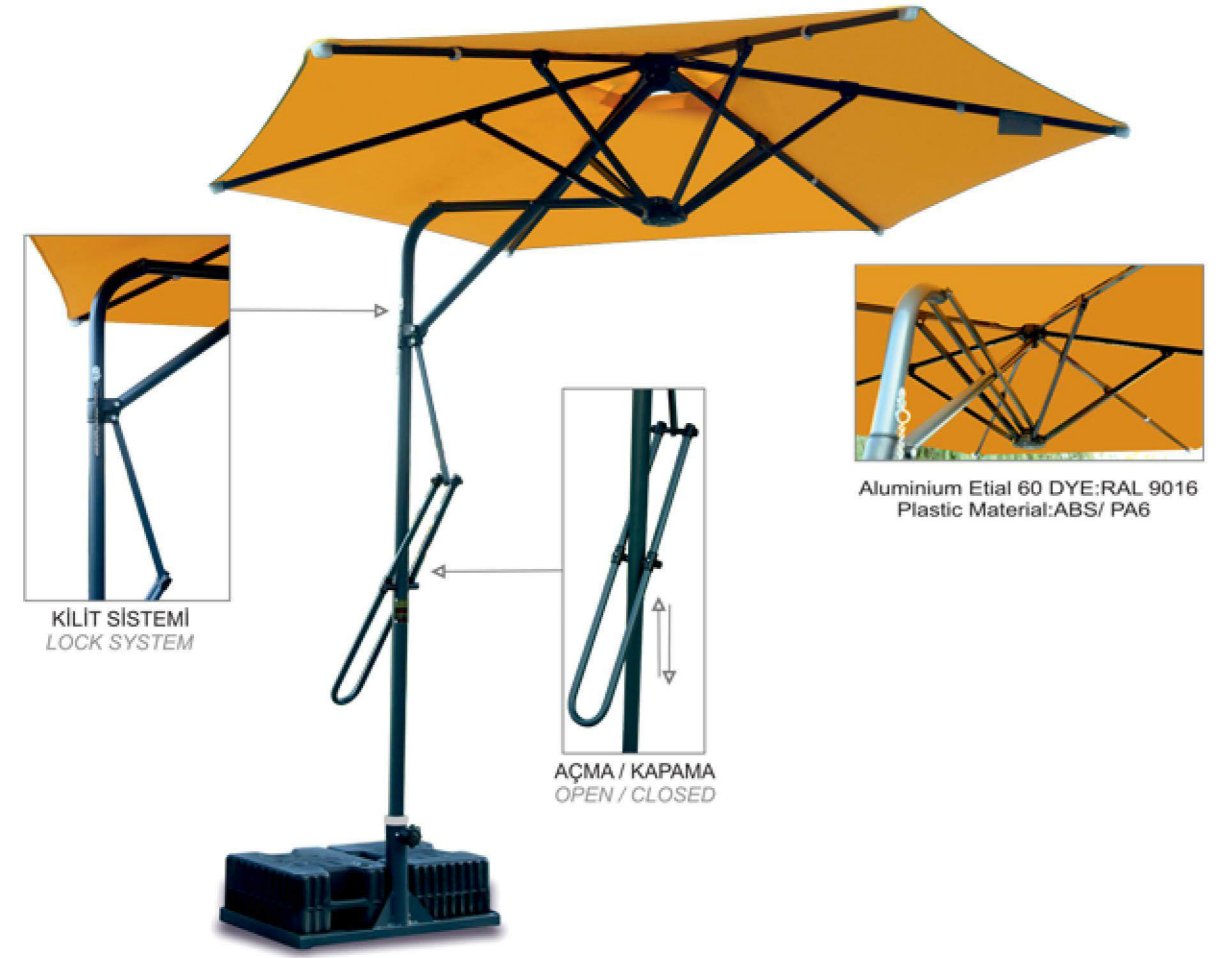

Cafe-Restaurant kullanımına uygun manuel sistem ile çalışan 6 kollu,metal ve alümiyumdan üretilmiş yuvarlak şekilde şemsiyedir. Beyaz veya istenilen RAL renkleri ile elektrostatik boya kaplanabilmekte,eloksal kaplamalı olarak üretilen şemsiyenin orta borusu Ø42x1,5 mm.dir.

İskelette bulunan plastik parçalar,tüm dünyada şemsiye üretiminde kullanılan kırılmaya karşı 2 yıl garantili ABS ve POLYAMID Pa6 PRIME hammadde kullanılarak üretilmiştir.

Şemsiyenin rüzgar tahliyesi tepe kısmında bulunan hava kanalları ile yapıldığı için şemsiyenizi rüzgarlı havalarda güvenle kullanabilirsiniz.

Şemsiyenin açma-kapama işlemi gövde üzerinde özel olarak üretilen mekanizmanın yukarı ve aşağı hareketi ile yapılır.

Özel olarak üretilen altlık ile şemsiyenizi 360 derece döndürebilirsiniz.

Polyester veya Akrilik kumaş seçeneği ile sizi yıllarca güneşten koruyabilir.

It is a round shaped umbrella made of metal,aluminum with 6 arms, suitable for cafe-restaurant use, working with a manuel system.

It can be coated with electrostatic paint with white or desired RAL colors, and the middle pipe of the umbrella,

which is produced as anodized, is Ø42x1,5 mm.

Plastic parts in the skeleton, ABS and POLYAMID with 2-year warranty against breakage, which are used in umbrella production all over the world.

It is produced using Pa6 PRIME raw material.

Since the wind evacuation of the umbrella is made with the air ducts on the top, you can safely use your umbrella in windy weather.

The opening-closing operation of the umbrella, the up and down movement of the mechanism specially produced on the body and

It is made by rotating the impeller system from the arm part.

You can rotate your umbrella 360 degrees with the specially produced base.

It can protect you from the sun for years with its polyester or acrylic fabric options.

ÖLÇÜLER / SIZES

SPY 250/8....Ø250 cm.

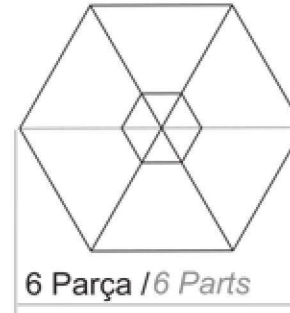

SPY 250/8

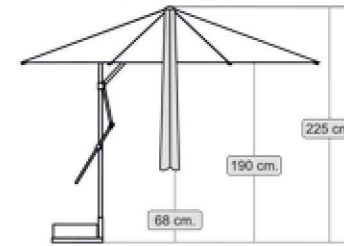

TEKNİK ÖZELLİKLER

TECHNICAL SPECIFICATIONS

KOD CODE	KAPLI ALAN AREA COVERED	AĞIRLIK WEIGHT	AMBALAJ PACKAGING
	m ²	Kg.	1 ad./pcs.
SPY 250/8	5	10	35x50x225 cm.

PROFİLLER / PROFILES

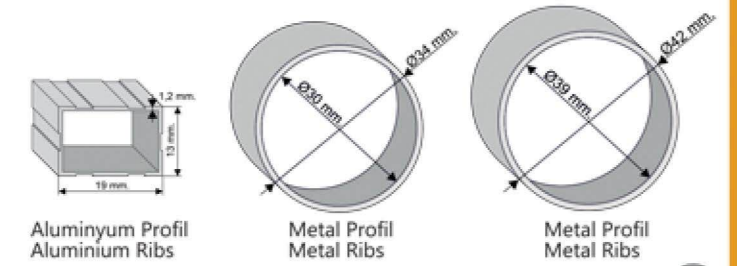

ALTLIKLAR / BASES



TKN-313
Ölçüler / Size
40x80 cm.
50 Kg./100 Kg.



TKN-314
Ölçüler / Size
70x70 cm.
60 Kg./ 120 Kg.

Altlıklar fiyatlara dahil değildir.
Bases are not included in the price.

MY DESIGN YUVARLAK MR DESIGN ROUND



Cafe-Restaurant kullanımına uygun teleskopik sistem ile çalışan 8 kollu, alüminyumdan üretilmiş yuvarlak şekilde şemsiyedir. Beyaz veya istenilen RAL renkleri ile elektrostatik boya kaplanabilmekte, eloksallı olarak üretilen şemsiyenin orta borusu 90X90 mm.'dir.

İskelette bulunan plastik parçalar, tüm dünyada şemsiye üretiminde kullanılan kırılmaya karşı 2 yıl garantili ABS ve POLYAMID Pa6 PRIME hammadde kullanılarak üretilmiştir.

Şemsiyenin rüzgar tahliyesi tepe kısmında bulunan hava kanalları ile yapıldığı için şemsiyenizi rüzgarlı havalarda güvenle kullanabilirsiniz.

Şemsiyenin açma-kapama işlemi gövde üzerinde özel olarak üretilen mekanizmanın yukarı ve aşağı hareketi ve çark sisteminin kol kısmından döndürülmesi ile yapılır.

Özel olarak üretilen altlık ile şemsiyenizi 360 derece döndürebilirsiniz.

Polyester veya Akrilik kumaş seçeneği ile sizi yıllarca güneşten koruyabilir.

It is a round shaped umbrella made of aluminum with 8 arms, suitable for cafe-restaurant use, working with a mechanical system.

It can be coated with electrostatic paint with white or desired RAL colors, and the middle pipe of the umbrella, which is produced as anodized, is 70X70 mm.

Plastic parts in the skeleton, ABS and POLYAMID with 2-year warranty against breakage, which are used in umbrella production all over the world.

It is produced using Pa6 PRIME raw material.

Since the wind evacuation of the umbrella is made with the air ducts on the top, you can safely use your umbrella in windy weather.

The opening-closing operation of the umbrella, the up and down movement of the mechanism specially produced on the body and

It is made by rotating the impeller system from the arm part.

You can rotate your umbrella 360 degrees with the specially produced base.

It can protect you from the sun for years with its polyester or acrylic fabric options.



ÖLÇÜLER / SIZES

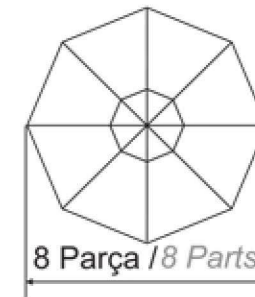

FPR 250/8....250 cm.

FPR 300/8....300 cm.

FPR 350/8....350 cm.

TEKNİK ÖZELLİKLER TECHNICAL SPECIFICATIONS

KOD CODE	KAPLI ALAN AREA COVERED	AĞIRLIK WEIGHT	AMBALAJ PACKAGING
	m ²	Kg.	1 ad./pcs.
FPR 250/8	5	22	27x27x210
FPR 300/8	7	25	27x27x210
FPR 350/8	9,6	28	27x27x210

PROFİLLER / PROFILES

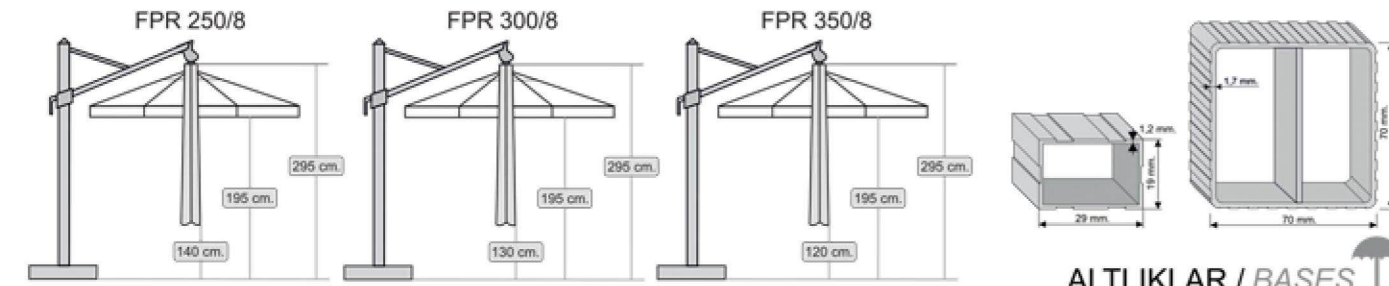

ALTIKLAR / BASES

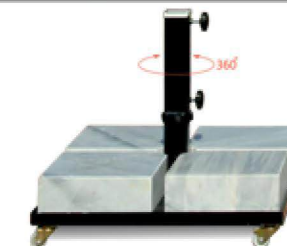

TKN-307
80x80 cm. / 230 kg.

Altıklar fiyatlara dahil değildir.
Bases are not included in the price.

MY DESIGN KARE MR DESIGN SQUARE



Cafe-Restaurant kullanımına uygun teleskopik sistem ile çalışan 8 kollu, alüminyumdan üretilmiş kare şekilde şemsiyedir.

Beyaz veya istenilen RAL renkleri ile elektrostatik boya kaplanabilmekte, eloksal kaplamalı olarak üretilen şemsiyenin orta borusu 90X90 mm.'dir.

İskelette bulunan plastik parçalar, tüm dünyada şemsiye üretiminde kullanılan kırılmaya karşı 2 yıl garantili ABS ve POLYAMID

Pa6 PRIME hammadde kullanılarak üretilmiştir.

Şemsiyenin rüzgar tahliyesi tepe kısmında bulunan hava kanalları ile yapıldığı için şemsiyenizi rüzgarlı havalarda güvenle kullanabilirsiniz.

Şemsiyenin açma-kapama işlemi gövde üzerinde özel olarak üretilen mekanizmanın yukarı ve aşağı hareketi ve

çark sisteminin kol kısmından döndürülmesi ile yapılır.

Özel olarak üretilen altlık ile şemsiyenizi 360 derece döndürebilirsiniz.

Polyester veya Akrilik kumaş seçeneği ile sizi yıllarca güneşten koruyabilir.

It is a square shaped umbrella made of aluminum with 8 arms, suitable for cafe-restaurant use, working with a mechanical system.

It can be coated with electrostatic paint with white or desired RAL colors, and the middle pipe of the umbrella,

which is produced as anodized, is 70X70 mm.

Plastic parts in the skeleton, ABS and POLYAMID with 2-year warranty against breakage, which are used in umbrella production all over the world.

It is produced using Pa6 PRIME raw material.

Since the wind evacuation of the umbrella is made with the air ducts on the top, you can safely use your umbrella in windy weather.

The opening-closing operation of the umbrella, the up and down movement of the mechanism specially produced on the body and

It is made by rotating the impeller system from the arm part.

You can rotate your umbrella 360 degrees with the specially produced base.

It can protect you from the sun for years with its polyester or acrylic fabric options.



ÖLÇÜLER / SIZES

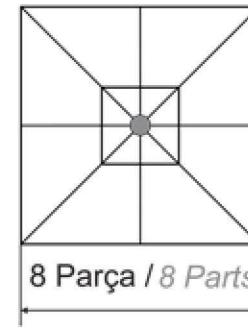

FPS 250x250/8....250x250 cm.

FPS 300x300/8....300x300 cm.

FPS 350x350/8....350x350 cm.

TEKNİK ÖZELLİKLER TECHNICAL SPECIFICATIONS

KOD CODE	KAPLI ALAN AREA COVERED	AĞIRLIK WEIGHT	AMBALAJ PACKAGING
	m ²	Kg.	1 ad./pcs.
FPS 250x250/8	6,25	32	27x27x210
FPS 300x300/8	9	35	27x27x210
FPS 350x350/8	12,2	38	27x27x210

PROFİLLER / PROFILES

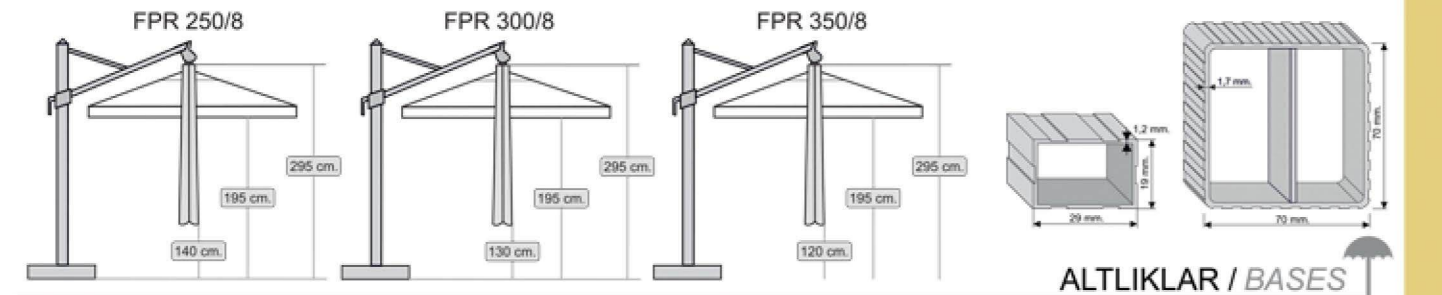

ALTLIKLAR / BASES

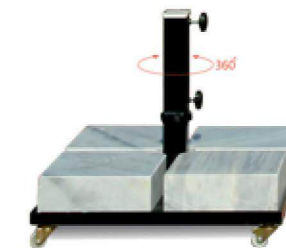

TKN-307
80x80 cm. / 230 kg.

Altlıklar fiyatlara dahil değildir.
Bases are not included in the price.



TWINS MY DESIGN

TWINS MY DESIGN YUVARLAK

TWINS MY DESIGN ROUND



Cafe-Restaurant kullanımına uygun mekanik sistem ile çalışan 8 kollu, alüminyumdan üretilmiş yuvarlak şekilde şemsiyedir.

Beyaz veya istenilen RAL renkleri ile elektrostatik boya kaplanabilmekte, eloksal kaplamalı olarak üretilen şemsiyenin orta borusu 90X90 mm.'dir.

İskelette bulunan plastik parçalar, tüm dünyada şemsiye üretiminde kullanılan kırılmaya karşı 2 yıl garantili ABS ve POLYAMID

Pa6 PRIME hammadde kullanılarak üretilmiştir.

Şemsiyenin rüzgar tahliyesi tepe kısmında bulunan hava kanalları ile yapıldığı için şemsiyenizi rüzgarlı havalarda güvenle kullanabilirsiniz.

Şemsiyenin çalışması özel olarak üretilen dişli sistemi hareket ettirilerek çelik halatın şemsiye kollarını açması ile sağlanır.

Özel olarak üretilen altlık ile şemsiyenizi 360 derece döndürebilirsiniz.

Polyester veya Akrilik kumaş seçeneği ile sizi yıllarca güneşten koruyabilir.

It is an 8-arm, round umbrella made of aluminum, operating with a telescopic system suitable for cafe-restaurant use.

It can be coated with electrostatic paint with white or desired RAL colors, and the middle pipe of the umbrella, which is produced as anodized, is 90X90 mm.

Plastic parts in the skeleton, ABS and POLYAMID with 2-year warranty against breakage, which are used in umbrella production all over the world.

It is produced using Pa6 PRIME raw material.

Since the wind evacuation of the umbrella is made with the air ducts on the top, you can safely use your umbrella in windy weather.

The operation of the umbrella is provided by moving the specially produced gear system and opening the umbrella arms of the steel rope.

You can rotate your umbrella 360 degrees with the specially produced base.

It can protect you from the sun for years with its polyester or acrylic fabric options.



ÖLÇÜLER / SIZES

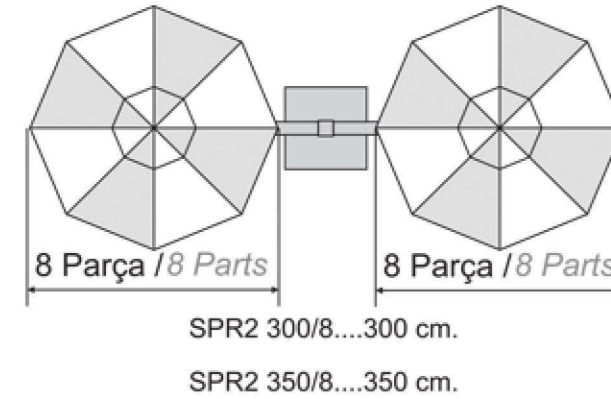

SPR2 300/8.....300 cm.

SPR2 350/8.....350 cm.

TEKNİK ÖZELLİKLER / TECHNICAL SPECIFICATIONS

KOD CODE	KAPLI ALAN AREA COVERED	AĞIRLIK WEIGHT	AMBALAJ PACKAGING
	m ²	Kg.	1 ad./pcs.
SPR2 300/8	7x2	45	27x27x270 cm.
SPR2 350/8	9,6x2	51	27x27x270 cm.

PROFİLLER / PROFILES

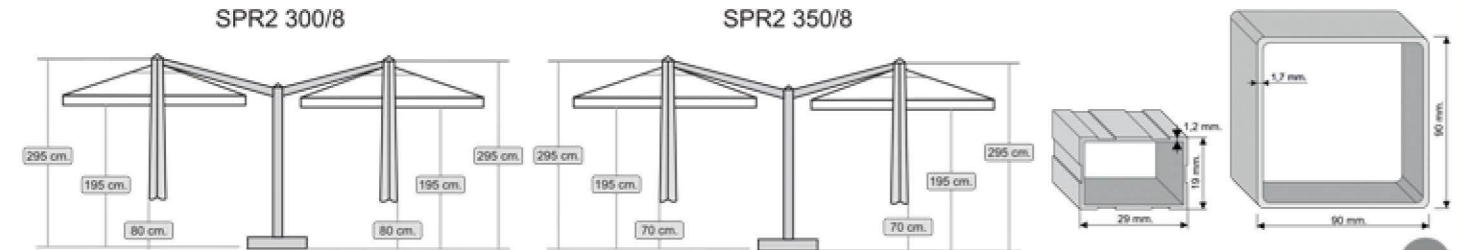

ALTIKLAR / BASES

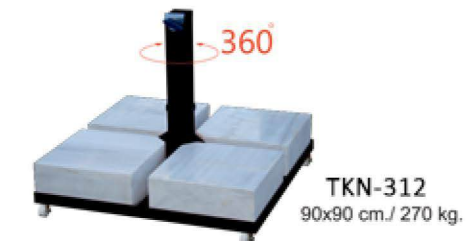

Altıklar fiyatlara dahil değildir.
Bases are not included in the price.

TWINS MY DESIGN KARE

TWINS MY DESIGN SQUARE



Cafe-Restaurant kullanımına uygun mekanik sistem ile çalışan 8 kollu, alüminyumdan üretilmiş kare şekilde şemsiyedir.

Beyaz veya istenilen RAL renkleri ile elektrostatik boya kaplanabilmekte, eloksal kaplamalı olarak üretilen şemsiyenin orta borusu 90X90 mm.'dir.

İskelette bulunan plastik parçalar, tüm dünyada şemsiye üretiminde kullanılan kırılmaya karşı 2 yıl garantili ABS ve POLYAMID

Pa6 PRIME hammadde kullanılarak üretilmiştir.

Şemsiyenin rüzgar tahliyesi tepe kısmında bulunan hava kanalları ile yapıldığı için şemsiyenizi rüzgarlı havalarda güvenle kullanabilirsiniz.

Şemsiyenin çalışması özel olarak üretilen dişli sistemi hareket ettirilerek çelik halatın şemsiye kollarını açması ile sağlanır.

Özel olarak üretilen altlık ile şemsiyenizi 360 derece döndürebilirsiniz.

Polyester veya Akrilik kumaş seçeneği ile sizi yıllarca güneşten koruyabilir.

It is an 8-arm, square umbrella made of aluminum, operating with a telescopic system suitable for cafe-restaurant use.

It can be coated with electrostatic paint with white or desired RAL colors, and the middle pipe of the umbrella, which is produced as anodized, is 90X90 mm.

Plastic parts in the skeleton, ABS and POLYAMID with 2-year warranty against breakage, which are used in umbrella production all over the world.

It is produced using Pa6 PRIME raw material.

Since the wind evacuation of the umbrella is made with the air ducts on the top, you can safely use your umbrella in windy weather.

The operation of the umbrella is provided by moving the specially produced gear system and opening the umbrella arms of the steel rope.

You can rotate your umbrella 360 degrees with the specially produced base.

It can protect you from the sun for years with its polyester or acrylic fabric options.



ÖLÇÜLER / SIZES

SPS2 300x300/8....300x300 cm.

SPS2 350x350/8....350x350 cm.

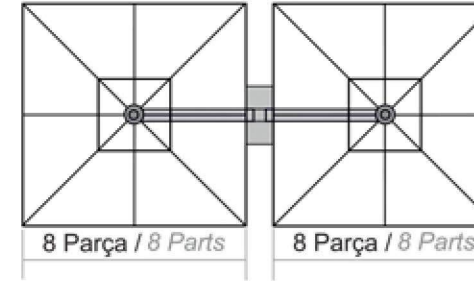

TEKNİK ÖZELLİKLER TECHNICAL SPECIFICATIONS

KOD CODE	KAPLI ALAN AREA COVERED	AĞIRLIK WEIGHT	AMBALAJ PACKAGING
	m ²	Kg.	1 ad./pcs.
SPS2 300x300/8	9x2	45	40x40x270cm.
SPS2 350x350/8	12,2x2	51	40x40x270cm.

PROFİLLER / PROFILES

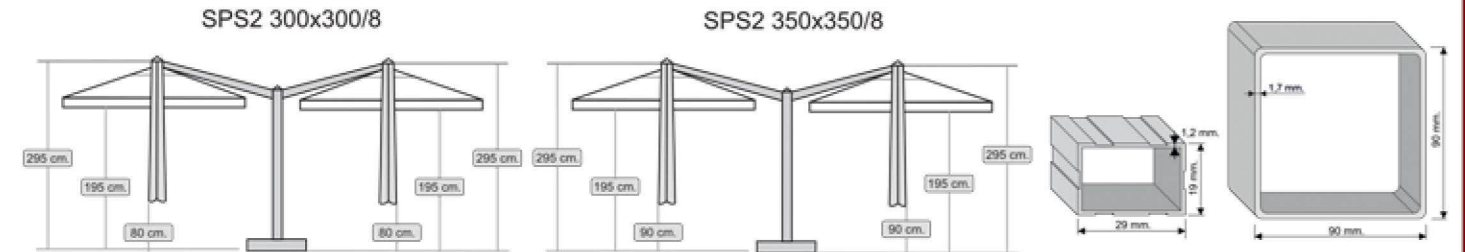

ALTLIKLAR / BASES

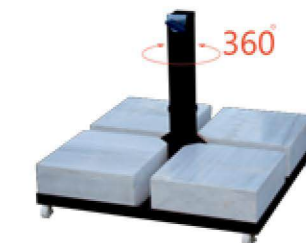

Altlıklar fiyatlara dahil değildir.
Bases are not included in the price.



PLAJ ŞEMSIYESİ

PLAJ ŐEMSIYESİ

BEACH PARASOL



Bahçenizde,balkonda,plajda veya havuz kenarında kullanabileceğinizin Ø 180 cm. 8 telli ve Ø 200 cm. 10 telli Őemsiyedir.

Tel kalınlığı 3,8 mm. olup yüksek kaliteli karbon çelikten üretilmiştir.

İskelette bulunan plastik parçalar,tüm dünyada Őemsiye üretiminde kullanılan kırılmaya karşı 2 yıl garantili ABS ve POLYAMID

Pa6 PRIME hammadde kullanılarak üretilmiştir.

Açma-Kapama sistemi bas-bırak mandalı ile kolay bir şekilde yapılabilmektedir.

Őemsiyeyi açmak için mandal bastırılarak,yukarıya hareket ettirilerek ve sabitleyici yuvasına takılması ile yapılır.

Kapatma işlemi için mandal bastırılarak aşağı doğru bırakılır.

Őemsiyeyi güneş yönüne çevirmek 180 derece head-tilt sistemi sayesinde yapılmaktadır.

Polyester kumaş ve renk seçeneđi ile sizi yıllarca güneşten koruyabilir.

Ø 180 cm, which you can use in your garden, balcony, beach or by the pool. 8 strings and Ø 200 cm. It is a 10-string umbrella.

Wire thickness 3.8 mm. and is made of high quality carbon steel.

Plastic parts in the skeleton, ABS and POLYAMID with 2-year warranty against breakage, which are used in umbrella production all over the world.

It is produced using Pa6 PRIME raw material.

The on-off system can be made easily with the push-release latch.

To open the umbrella is done by pressing the latch, moving it upwards and attaching it to the fixer slot.

For closing, the latch is pressed and left down.

Turning the umbrella in the direction of the sun is done by the 180 degree head-tilt system.

It can protect you from the sun for years with its polyester fabric and color options.

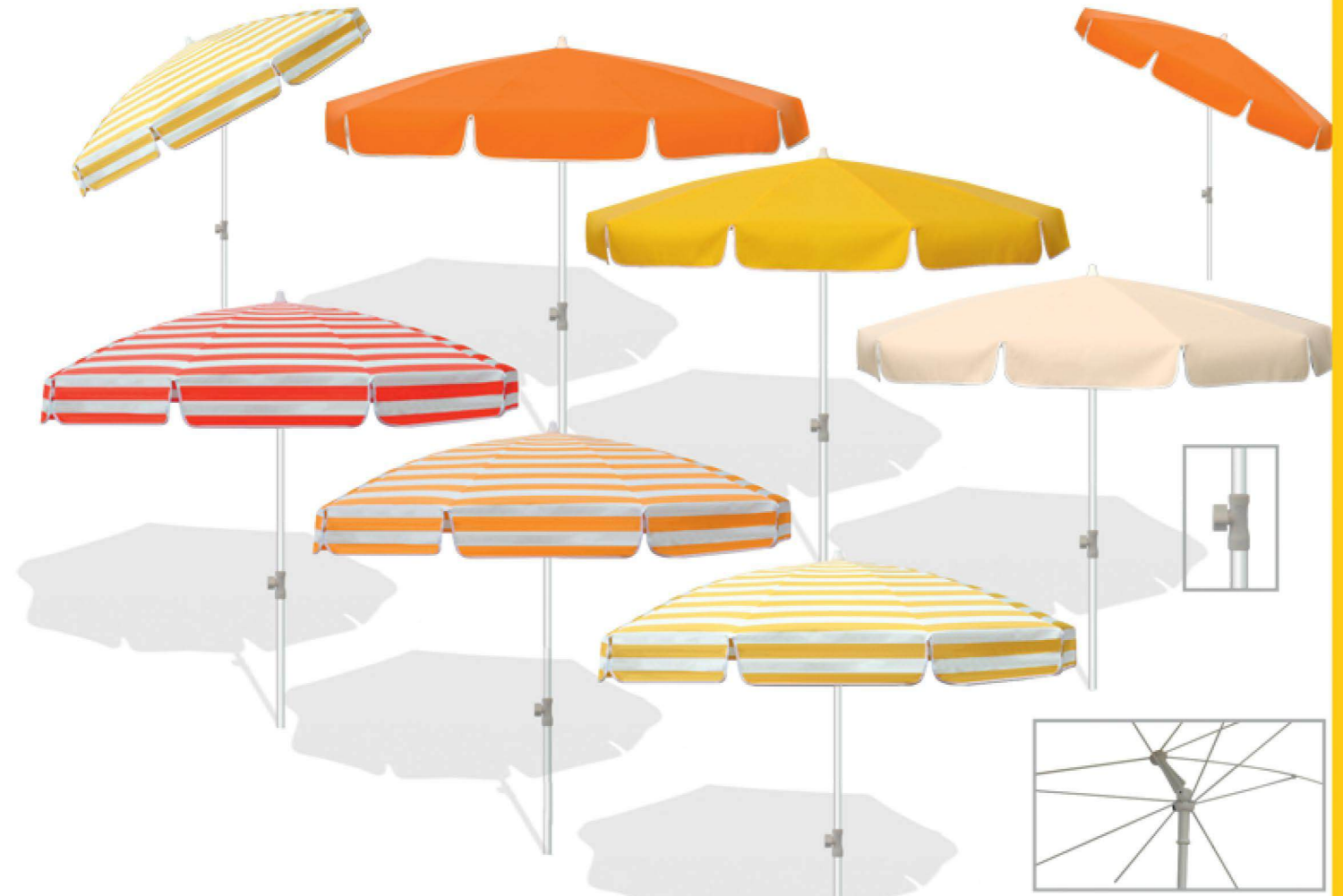

ÖLÇÜLER / SIZES

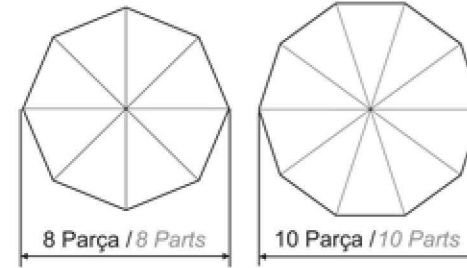

PLS 180/8....180 cm.

PLS 200/8....200 cm.

PLS 200/10..200 cm.

TEKNİK ÖZELLİKLER

TECHNICAL SPECIFICATIONS

KOD CODE	KAPLI ALAN AREA COVERED	AĞIRLIK WEIGHT	AMBALAJ PACKAGING 1 ad./pcs.	AMBALAJ PACKAGING 12 ad./pcs.
	m ²	Kg.	cm.	cm.
PLS 180/8	2,5	3-36	10x10x125	27x27x125
PLS 200/8	3,1	3-36	10x10x125	27x27x125
PLS 200/10	3,1	3,5-42	10x10x125	27x27x125

PROFİLLER / PROFILES

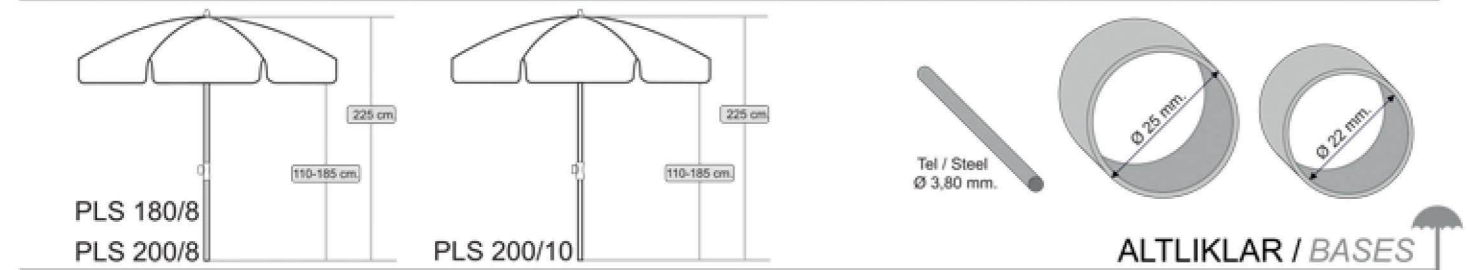

ALTIKLAR / BASES



TKN -1020-20 lt.
Ağırlık/Weight: 20 lt..
Boyut/Size : 47x47x13 cm.



TKN -1030-32 lt.
Ağırlık/Weight: 32 lt..
Boyut/Size : 53x53x16 cm.



BUZDOLABI ŐEMSIYE APARATI
FRIDGE UMBRELLA HOLDER

Altlıklar fiyatlara dahil değildir.
Bases are not included in the price.

MEGA PLAJ ŐEMSİYESİ

MEGA BEACH PARASOL



Bahçenizde, balkonda, plajda veya havuz kenarında kullanabileceğiniz Ø 230 cm. 10 telli ve Ø 250 cm. 10 telli Őemsiyedir.

Tel kalınlığı 4,5 mm. olup yüksek kaliteli karbon çelikten üretilmiştir.

İskelette bulunan plastik parçalar, tüm dünyada Őemsiye üretiminde kullanılan kırılmaya karşı 2 yıl garantili ABS ve POLYAMID

Pa6 PRIME hammadde kullanılarak üretilmiştir.

Açma-Kapama sistemi bas-bırak mandalı ile kolay bir şekilde yapılabilmektedir.

Őemsiyeyi açmak için mandal bastırılarak, yukarıya hareket ettirilerek ve sabitleyici yuvasına takılması ile yapılır.

Kapatma işlemi için mandal bastırılarak aşağı doğru bırakılır.

Őemsiyeyi güneş yönüne çevirmek 180 derece head-tilt sistemi sayesinde yapılmaktadır.

Polyester kumaş ve renk seçeneği ile sizi yıllarca güneşten koruyabilir.

Ø 230 cm, which you can use in your garden, balcony, beach or by the pool. 10 strings and Ø 250 cm. It is a 10-string umbrella.

Wire thickness 4.5 mm. and is made of high quality carbon steel.

Plastic parts in the skeleton, ABS and POLYAMID with 2-year warranty against breakage, which are used in umbrella production all over the world.

It is produced using Pa6 PRIME raw material.

The on-off system can be made easily with the push-release latch.

To open the umbrella is done by pressing the latch, moving it upwards and attaching it to the fixer slot.

For closing, the latch is pressed and left down.

Turning the umbrella in the direction of the sun is done by the 180 degree head-tilt system.

It can protect you from the sun for years with its polyester fabric and color options.

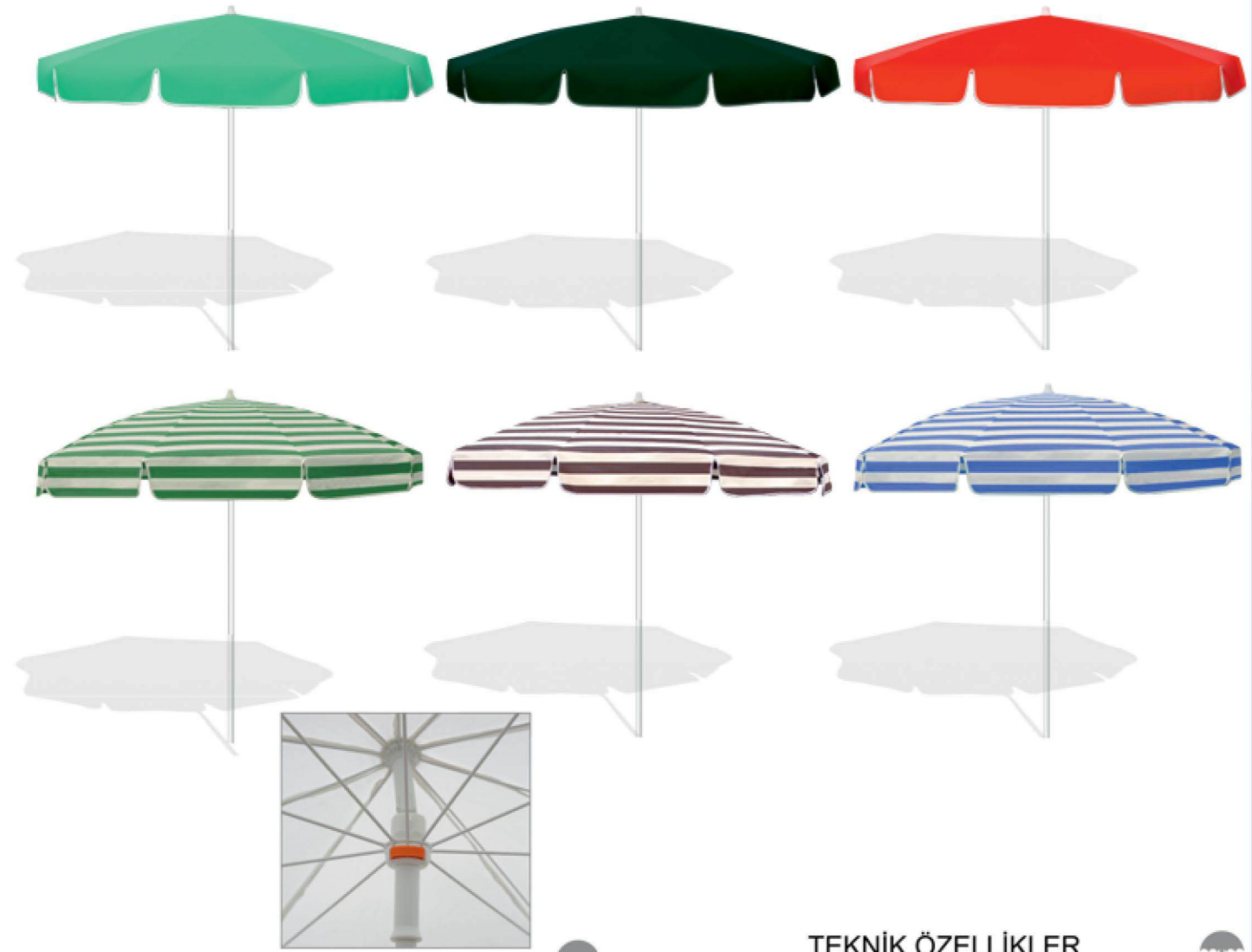

ÖLÇÜLER / SIZES

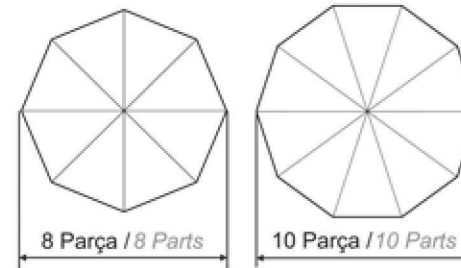

KOD CODE	KAPLI ALAN AREA COVERED	AĞIRLIK WEIGHT	AMBALAJ PACKAGING 1 ad./pcs.	AMBALAJ PACKAGING 12 ad./pcs.
MPL 230/10....230 cm.	MPL 230/10	4,1	4-48	15x15x160
MPL 250/10....250 cm.	MPL 250/10	3,9	4-48	15x15x160

TEKNİK ÖZELLİKLER TECHNICAL SPECIFICATIONS

KOD CODE	KAPLI ALAN AREA COVERED	AĞIRLIK WEIGHT	AMBALAJ PACKAGING 1 ad./pcs.	AMBALAJ PACKAGING 12 ad./pcs.
	m ²	Kg.	cm.	cm.

PROFİLLER / PROFILES

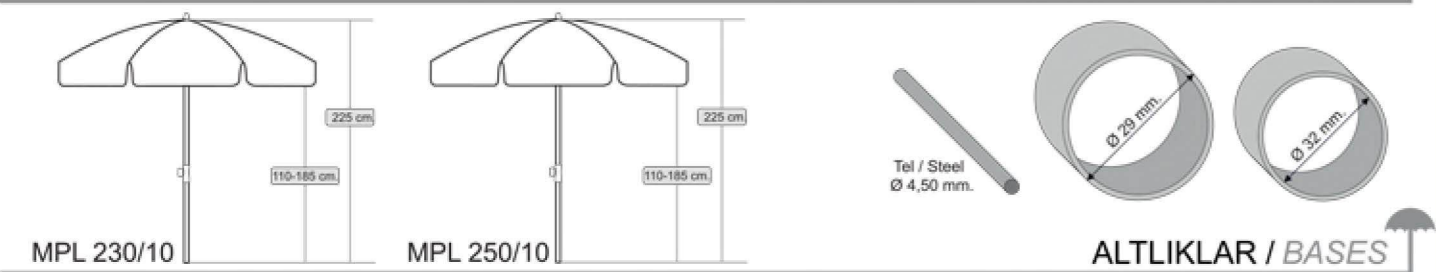

ALTIKLAR / BASES



TKN-1030-32 lt.
Ağırlık/Weight: 32 lt..
Boyut/Size: 53x53x16 cm.



TKN-1040-50 lt.
Ağırlık/Weight: 50 lt..
Boyut/Size: 53x53x23 cm.

Altıklar fiyatlara dahil değildir.
Bases are not included in the price.

TKN-1020-20 lt.

Malzeme / Raw Material
HDPE
Yüksek Yoğunluk Polietilen

Ölçüler / Size
47x47x13 cm.

Boş Ağırlık / Weight Empty
0,95 Kg.

Su Dolu Ağırlık / Filled With Water
20 Kg.

Kum Dolu Ağırlık / Filled With Sand
40 kg.

Boru Ölçüsü / Stick Size
Ø 22 / Ø 32 mm.

Ambalaj / Packaging
1 paket:10 adet / 1 Packed:10 Pieces
10 kg. 47x47x130 cm.



TKN- X-1030-32 lt.

Malzeme / Raw Material
HDPE
Yüksek Yoğunluk Polietilen

Ölçüler / Size
53x53x16 cm.

Boş Ağırlık / Weight Empty
1,45 Kg.

Su Dolu Ağırlık / Filled With Water
32 Kg.

Kum Dolu Ağırlık / Filled With Sand
60 kg.

Boru Ölçüsü / Stick Size
Ø 22 / Ø 32 mm.
Ø 38 / Ø 40 / Ø 42 mm.

Ambalaj / Packaging
1 paket:5 adet / 1 Packed:5 Pieces
7,45 kg. 53x53x80 cm.

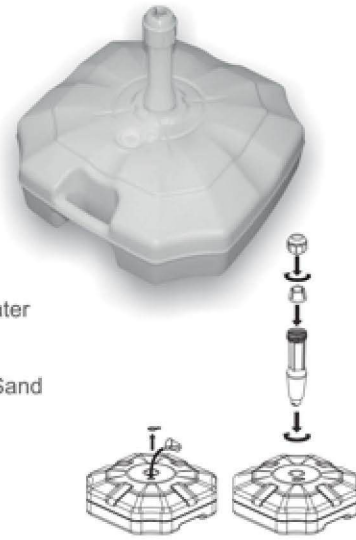

TKN- 200

Ölçüler / Size
80x80 cm.
Beton Dolgulu Ağırlık
Filled With Concrete
200 Kg.

Kum Dolu Ağırlık
Filled With Sand
180 Kg.

Su Dolu Ağırlık
Filled With Water
100 Kg.

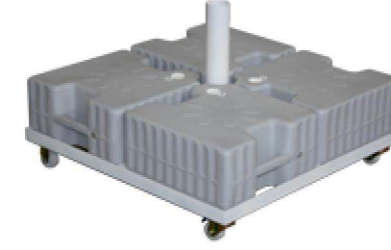

TKN- 201

Ölçüler / Size
90x90 cm.
Beton Dolgulu Ağırlık
Filled With Concrete
260 Kg.

Kum Dolu Ağırlık
Filled With Sand
230 Kg.

Su Dolu Ağırlık
Filled With Water
130 Kg.



TKN- 301 TKN- 302 TKN- 303 TKN- 304 TKN- 305 TKN- 306

Ölçüler / Size 50x50 cm. Ölçüler / Size 60x60 cm. Ölçüler / Size 70x70 cm. Ölçüler / Size 80x80 cm. Ölçüler / Size 90x90 cm. Ölçüler / Size 100x100 cm.

Ağırlık / Weight 80 Kg. Ağırlık / Weight 100 Kg. Ağırlık / Weight 140 Kg. Ağırlık / Weight 230 Kg. Ağırlık / Weight 270 Kg. Ağırlık / Weight 350 Kg.



TKN- W-1050-75 lt.

Malzeme / Raw Material
HDPE
Yüksek Yoğunluk Polietilen

Ölçüler / Size
62x62x24 cm.

Boş Ağırlık / Weight Empty
3,7 Kg.

Su Dolu Ağırlık / Filled With Water
75 Kg.

Kum Dolu Ağırlık / Filled With Sand
150 kg.

Boru Ölçüsü / Stick Size
Ø 32 / Ø 36 mm.
Ø 40 / Ø 50 mm.

Ambalaj / Packaging
1 paket:4 adet / 1 Packed:4 Pieces
15 kg. 62x62x114 cm.



TKN- W-1040-50 lt.

Malzeme / Raw Material
HDPE
Yüksek Yoğunluk Polietilen

Ölçüler / Size
53x53x23 cm.

Boş Ağırlık / Weight Empty
2,75 Kg.

Su Dolu Ağırlık / Filled With Water
50 Kg.

Kum Dolu Ağırlık / Filled With Sand
100 kg.

Boru Ölçüsü / Stick Size
Ø 32 / Ø 36 mm.
Ø 40 / Ø 50 mm.

Ambalaj / Packaging
1 paket:4 adet / 1 Packed:4 Pieces
11,5 kg. 53x53x110 cm.



TKN- 308
Ölçüler / Size
80x80 cm.

TKN- 309
Ölçüler / Size
90x90 cm.

TKN- 310
Ölçüler / Size
100x100 cm.

METAL KAPAK



TKN- 307
Ölçüler / Size
83x83 cm.

Ağırlık / Weight
230 Kg.

TKN- 312
Ölçüler / Size
90x90 cm.

Ağırlık / Weight
270 Kg.

TKN- LUX-3010-50 kg

Ölçüler / Size
52x52x15 cm.

Ağırlık / Weight
50 Kg.

Beton Dolgulu
Filled With Concrete



TKN- LUXURY-3020-75 kg

Ölçüler / Size
62x62x15 cm.

Ağırlık / Weight
75 Kg.

Beton Dolgulu
Filled With Concrete



TKN- 311
Ölçüler / Size
50x50 cm.

Yere monte edilebilen ayak



Fridge Umbrella Holder



TKN- 500
Küllük / Ashtray
Ø 16 cm.

Functional Table
Ölçüler / Size
Ø 50 cm.
Boru Çapı / Pipe Size
Ø 40 mm.
Ø 50 mm.



TKN- 313
Ölçüler / Size
40x80 cm.

Beton Dolgulu Ağırlık
Filled With Concrete
100 Kg.

Kum Dolu Ağırlık
Filled With Sand
90 Kg.

Su Dolu Ağırlık
Filled With Water
50 Kg.

TKN- 314
Ölçüler / Size
70x70 cm.

Kum Dolu Ağırlık
Filled With Sand
120 Kg.

Su Dolu Ağırlık
Filled With Water
60 Kg.

TAMAMLAYICILAR

PLAJ MİNDERİ / BEACH CUSHION

75x75 cm. / 100x100 cm. / 120x120 cm.



PLAJ BAYRAKLARI / BEACH FLAG

70x300 cm. / 70x400 cm.

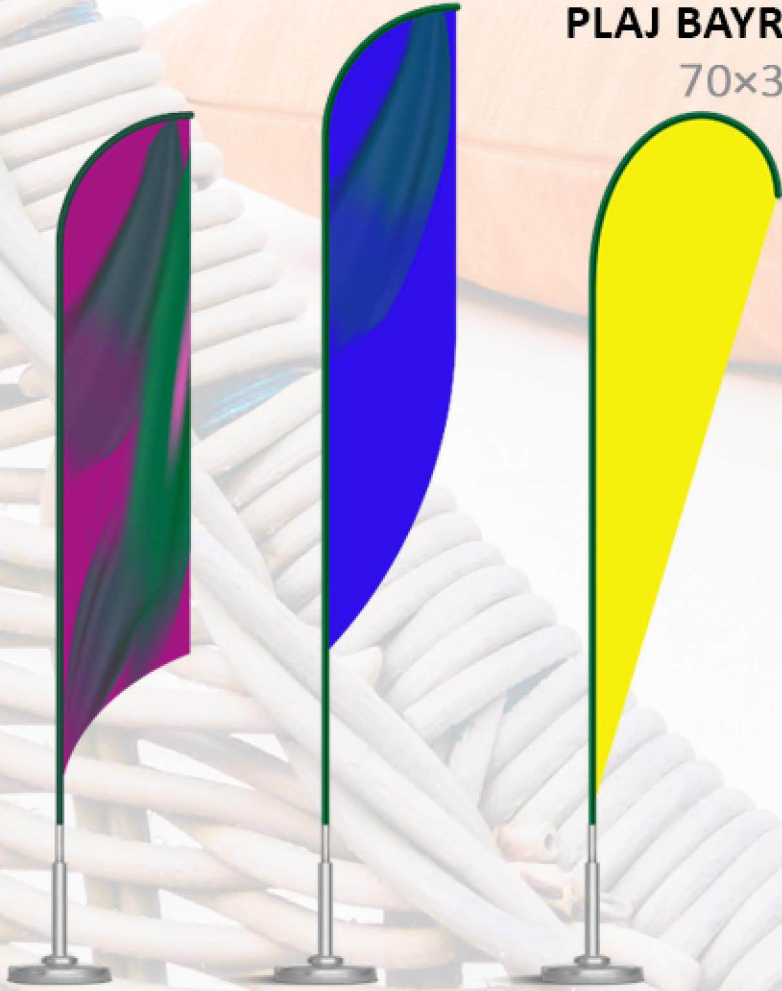

ŞEZLONG MİNDERİ / DECK CHAIRS

180x55x5 cm.



KATLANABİLİR ÇARDAK / FOLDABLE GAZEBO

300x600 cm. / 400x600 cm.

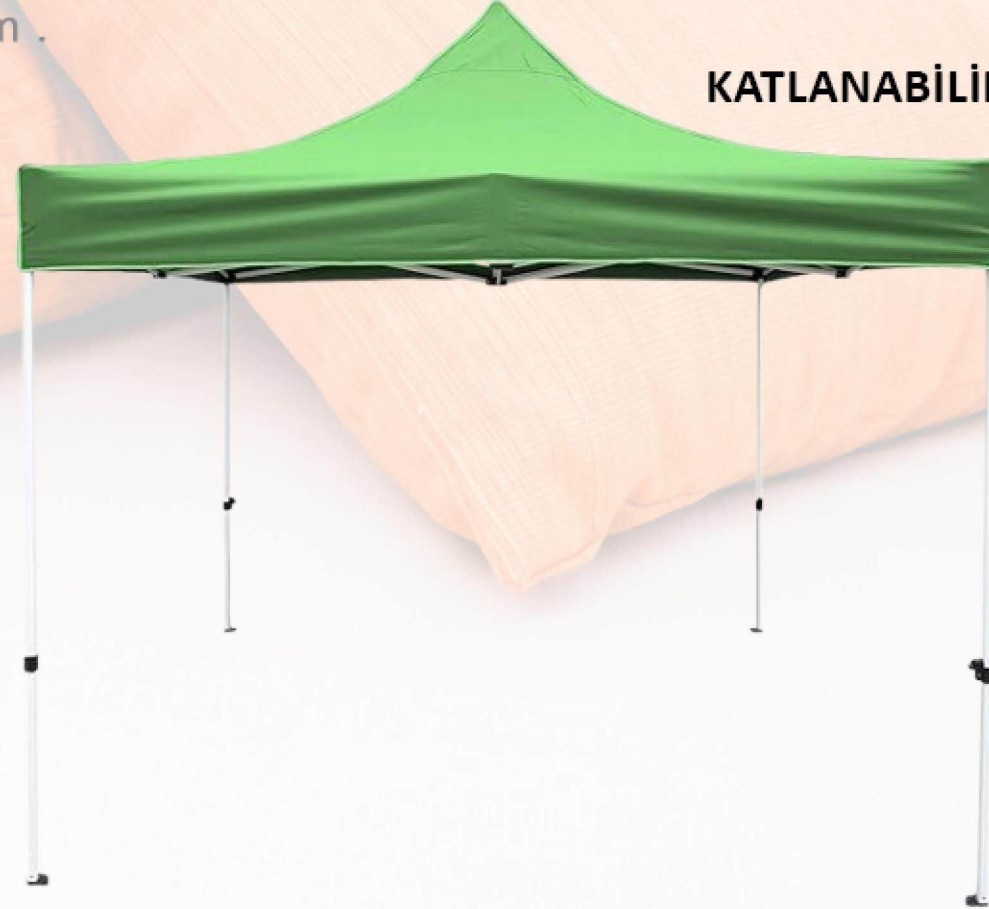

MİNDER GRUBU / PLAJ BAYRAKLARI





TEKİN ŞEMSIYE®

Güvenle Açılan Şemsiye

— Since 1986 —

 /tekinsemsiye

 +90 534 397 21 44
0212 482 06 06

 info@tekintextile.com



AVRUPA BÖLGE TEMSİLCİSİ / EUROPEAN REGIONAL REPRESENTATIVE

Steller Straße 32, 27755 Delmenhorst - GERMANY

+ 49 0172 416 47 57